**User's
Manual**

**Model 704430
TA120F
Digital Jitter Meter
Optional Function**

Thank you for purchasing the YOKOGAWA TA120F Digital Jitter Meter.
This user's manual describes only the optional function of the TA120F Digital Jitter Meter. To ensure correct use, please read this manual thoroughly before beginning operation. For the functions of the standard product, see the TA120F Digital Jitter Meter User's Manual (IM704430-01E).

After reading the manual, keep it in a convenient location for quick reference whenever a question arises during operation.

Notes

- The contents of this manual are subject to change without prior notice as a result of continuing improvements to the instrument's performance and functions. The figures given in this manual may differ from the actual screen.
- Every effort has been made in the preparation of this manual to ensure the accuracy of its contents. However, should you have any questions or find any errors, please contact your nearest YOKOGAWA dealer as listed on the back cover of this manual.
- Copying or reproducing all or any part of the contents of this manual without the permission of Yokogawa Electric Corporation is strictly prohibited.

Trademarks

Company and product names used in this manual are trademarks or registered trademarks of their respective holders.

Adobe and Adobe Acrobat are trademarks of Adobe Systems Incorporated (Adobe Systems).

Revisions

First Edition: July 2001

Symbols Used in This Manual

Displayed characters

SHIFT+key means you will press to turn ON the indicator that is located above and to the left of followed by the key. The action that is indicated above the corresponding key is carried out.

Notes

The following symbols are used in this manual.



A symbol affixed to the instrument. Indicates danger to personnel or instrument and the operator must refer to the user's manual. The symbol is used in the user's manual as a mark on the reference page.

WARNING

Describes precautions that should be observed to prevent injury or death to the user.

CAUTION

Describes precautions that should be observed to prevent minor or moderate injury, or damage to the instrument.

Note

Provides important information for the proper operation of the instrument.

Symbols used in the explanation of operations

On pages that describe operating procedures, the following symbols are used to distinguish the procedures from their explanations:

Keys

Indicates the keys related to the operation.

Procedure

Carry out the procedure according to the step numbers. The procedure is given with the premise that the user is carrying out the procedure for the first time. Depending on the operation, you may not need to carry out all the steps.

Explanation

Describes the details of the settings and the restrictions that exist with the operating procedure. A detailed description of the function is not provided in this section. For a detailed description of the function, see section 1.

Contents

1. Explanation of Functions	4
2. Setting the BI-PHASE Measurement Function	10
3. Setting the DC Output during BI-PHASE Measurement	12
4. Setting the Level Measurement Output	15
5. Communication Commands	20
6. Connection to the EXT I/O Terminal	25
7. Performance Tests	26
8. Specifications	29
Index	31

1. Explanation of Functions

The TA120F has the following three options: BI-PHASE measurement function, level measurement function, and EXT I/O terminal. An overview of the differences between a standard product and a product with options is given below.

BI-PHASE Measurement Function

BI-PHASE pulse width measurement

Measures the pulse width from the rising slope to the next falling slope (positive side) or from the falling slope to the next rising slope (negative side) of the demodulation signal (BI-PHASE) of the wobble of the optical disk track. The principle used to measure the BI-PHASE pulse width is the same as that used to measure the 3T data signal of a compact disk (CD). This function measures the pulse width jitter and the average value of 1T of the BI-PHASE signal.

BI-PHASE jitter σ and jitter ratio σ/T

Determines the histogram (frequency distribution) from the measured values in the range defined by $(158.730 \pm 80.000 \mu\text{s})/N$ (where N is the $\times N$ speed) within the BI-PHASE pulse width and derives the standard deviation σ . This standard deviation σ is the BI-PHASE jitter. The BI-PHASE jitter ratio is the percentage σ/T that is derived by dividing the standard deviation σ by period T ($(158.730 \mu\text{s})/N$ (where N is the $\times N$ speed)) of the BI-PHASE clock.

Numerical display of BI-PHASE jitter and jitter ratio

You can display the BI-PHASE jitter or BI-PHASE jitter ratio using a numerical value. You can also switch which value is to be displayed.

Numerical display of the average value

In addition to the jitter σ and jitter ratio σ/T , you can also display the numerical value of the average AVE that is calculated in the process of deriving these values. The average value of the selected measurement function is displayed. By switching the display, you can show this value in the same display as the numerical display of the jitter and jitter ratio as described above.

Note

You can also read statistics other than jitter, jitter ratio, and average value by making inquiries using communication commands. For details, see section 8.7.2, "CALCulation Group" in the TA120F Digital Jitter Meter User's Manual (IM704430-01E).

DC output of BI-PHASE jitter

The BI-PHASE jitter can be converted to DC voltage (0 V to 5 V) and output from the jitter DC output connector on the rear panel.

- **Jitter determination**

You can set a determination level in terms of the BI-PHASE jitter value (unit: μs) and output 5 V and 0 V of DC voltage when the signal is less than or equal to the determination level and above the determination level, respectively.

- **DC output filter**

Takes the moving average of the BI-PHASE jitter that has been measured. This is the same function as the DC output filter of the standard product.

Turning ON/OFF the equalizer

You cannot turn ON/OFF the equalizer when the measurement function is set to BI-PHASE jitter. Even if the equalizer is turned ON when the measurement function is set to 3T or D-to-C jitter, the equalizer function is disabled when you switch the measurement function to BI-PHASE jitter. The equalizer returns to the original setting when the measurement function is switched back to 3T or D-to-C jitter.

Setting the trigger mode and slice level

- **Selecting the trigger mode**

When the measurement function is set to BI-PHASE jitter, the trigger mode is fixed to MAN (manual mode). You cannot select other modes. Even if another trigger mode is selected when the measurement function is set to 3T or D-to-C jitter, the trigger mode is set to MAN when you switch the measurement function to BI-PHASE jitter. The trigger mode returns to the original setting when the measurement function is switched back to 3T or D-to-C jitter.

- **Setting the slice level**

The setting operation is the same as the standard product. The range and resolution are as follows:

- Range: -5.000 V to 5.000 V
- Resolution: 1 mV

Setting the gate

You can select the time gate and manually set the gate time. You cannot select the event gate. The range of the gate time is the same as the standard product.

Setting the arming

Same as the standard product.

Setting inhibit

Same as the standard product.

Switching the clock signal

Not applicable to BI-PHASE jitter.

Adjusting the phase difference between the data signal and the clock signal

Not applicable to BI-PHASE jitter.

Meter display

Indicates the BI-PHASE jitter ratio (σ/T) on the analog meter in the same fashion as the standard product.

Numeric display

Displays the jitter, jitter ratio, or average value of the selected measurement function.

- Unit used when numerically displaying the BI-PHASE jitter (σ) or average value (AVE): μs
- Unit used when numerically displaying the BI-PHASE jitter ratio (σ/T): %

Level Measurement Function

P-P voltage level measurement of the input signal

First, the noise and overshoot of the signal input to the amplitude measurement circuit are removed by the filter. Next, the maximum and minimum values of the input signal are measured by the A/D converter within the amplitude measurement circuit. The difference is the P-P voltage level.

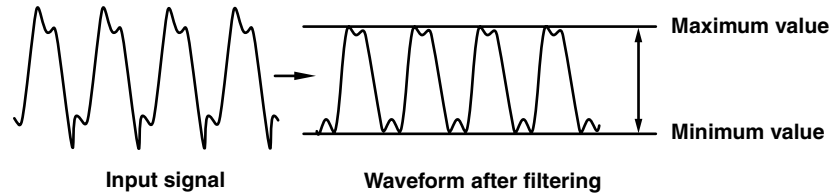

Level measurement display

When level measurement is turned ON, the measured P-P voltage level is shown in the same display as the numeric display by switching the display.

DC output of the level measurement

The P-P voltage level that has been measured can be converted to DC voltage (0 V to 5 V) and output from the level measurement DC output connector on the rear panel.

- **Level measurement determination**
You can set upper and lower limits for the level measurement (unit: V) and output 5 V and 0 V of DC voltage when the signal is within the determination level and outside the determination level, respectively.
- **DC output filter**
Takes the moving average of the P-P voltage level that has been measured. This is the same function as the DC output filter of the standard product.

EXT I/O (External I/O Terminal)

The EXT I/O terminal on the rear panel can be used to output the determination value of jitter or level measurement and recall the setup information corresponding to the specified preset number (setup information that has been stored using the preset function*)

* See chapter 6 in the TA120F Digital Jitter Meter User's Manual (IM704430-01E).

Front Panel

This section explains the sections that differ from the standard product.

Measurement indicator

Lights or blinks when the measured results are shown on the display ("σ/T," "σ," and "AVE" light when the jitter ratio, jitter, and average value of the measurement function is displayed, respectively. "σ/T" and "σ" light simultaneously when the level voltage is displayed during level measurement.)

FUNC key

Selects the measurement function ("BI-PHASExN" can be selected only on models with the BI-PHASE option function) and sets the xN speed.

OPTION key

Sets the level measurement function (turns ON/OFF level measurement, switches level output and determination output, and sets the upper and lower limits of range, upper and lower limits of determination, and moving average count).

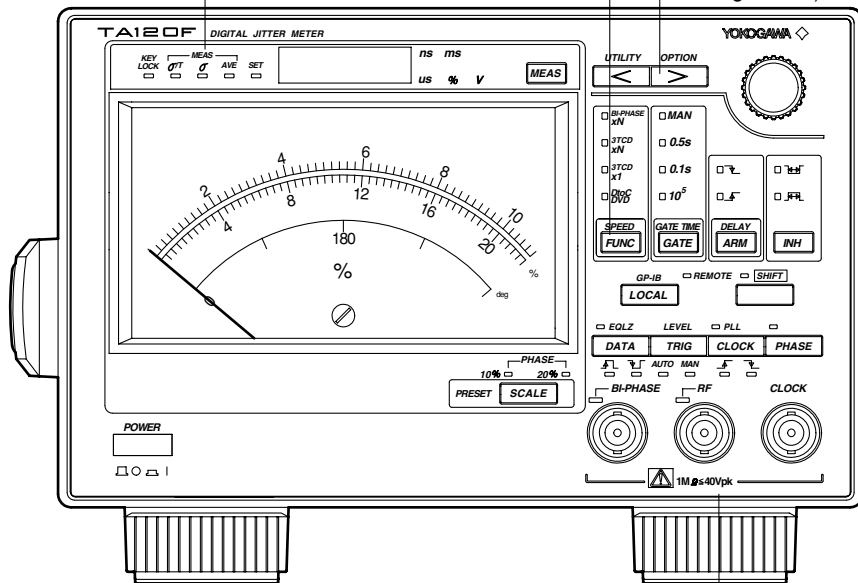

Signal input connector

Connects cables used to measure the BI-PHASE signal, RF signal, and clock signal.

Rear Panel

This section explains the sections that differ from the standard product.

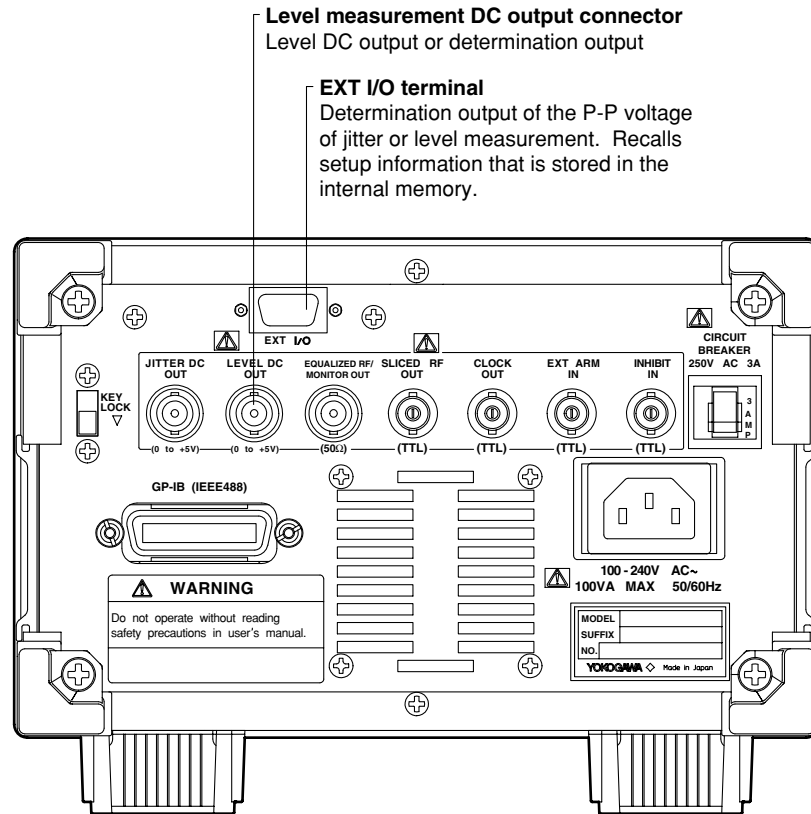

Power Up Operation

When the power switch is turned ON, "tA120F → 704430" appears on the 7-segment LED display followed by the suffix code name of the selected option. Then, the test program automatically starts. When the test program completes normally, "PASS" is shown on the display and the TA120F is ready to make measurements. The setup conditions are set to the settings that existed immediately before the power switch was turned OFF.

Backing Up the Setup Information

When an option is installed, the setup information of the following measurement conditions is stored using the lithium battery. Other information is stored in the same fashion as the standard product.

- **When the BI-PHASE measurement function is installed**

Item
Measurement function
Measured item (BI-PHASE jitter)
Manual setting of the $\times N$ speed (BI-PHASE jitter)
Polarity of the data signal
DC output mode of the BI-PHASE measurement
Determination level of the BI-PHASE measurement
Average coefficient of the BI-PHASE measurement output filter
Correction coefficient α of BI-PHASE measurement jitter (σ)
Correction coefficient β of BI-PHASE measurement jitter (σ)

- **When the level measurement function is installed**

Item
ON/OFF of level measurement
Level measurement mode
Upper limit of the level measurement output range
Lower limit of the level measurement output range
Upper limit of the level measurement output determination
Lower limit of the level measurement output determination
Average coefficient of the level measurement output filter

Initializing Setup Information

The following items are initialized when an option is installed. Other information is initialized in the same fashion as the standard product.

- **When the BI-PHASE measurement function is installed**

Item	Factory Default Settings
Manual setting of the $\times N$ speed (BI-PHASE jitter)	1.0
Polarity of the data signal (BI-PHASE jitter)	Rising slope
Gate type (BI-PHASE jitter)	0.1 s
Manual setting of the gate time	1000.0 ms
Trigger mode type (BI-PHASE jitter)	Manual mode
Slice level	2.500 V
DC output mode of the BI-PHASE measurement	Jitt
Determination level of the BI-PHASE measurement	16.000 μ s
Average coefficient of the BI-PHASE measurement output filter	1
Correction coefficient α of BI-PHASE measurement jitter (σ)	1.0000
Correction coefficient β of BI-PHASE measurement jitter (σ)	0.000 μ s

- **When the level measurement function is installed**

Item	Factory Default Settings
ON/OFF of level measurement	OFF
Level measurement mode	LEVEL
Upper limit of the level measurement output range	5.000 V
Lower limit of the level measurement output range	0.000 V
Upper limit of the level measurement output determination	3.000 V
Lower limit of the level measurement output determination	2.000 V
Average coefficient of the level measurement output filter	1

Key Lock

Same as the standard product.

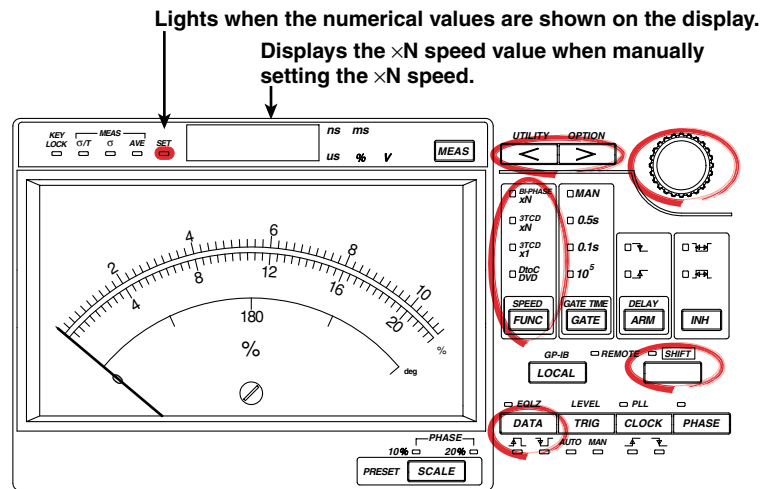

2. Setting the BI-PHASE Measurement Function

Keys



Procedure

Setting the measurement function to BI-PHASE jitter

1. Press **FUNC** to select BI-PHASE $\times N$. The BI-PHASE $\times N$ indicator lights.
 - **Manually setting the $\times N$ speed**
2. Press **SHIFT+FUNC (SPEED)**. The BI-PHASE $\times N$ indicator blinks and the $\times N$ speed value is shown on the display.
3. Use the **rotary knob** and **arrow (< or >)** keys to set the $\times N$ speed value.
For the procedure to set numeric values, see section 3.7 in the TA120F Digital Jitter Meter User's Manual (IM704430-01E).
- **Selecting the polarity of the BI-PHASE signal**
4. Press **DATA** to select “” or “”. The indicator of the selected item lights.

Explanation**Selecting BI-PHASE jitter**

The measurement range of the pulse width when determining the BI-PHASE jitter is $(158.730 \pm 80.000 \mu\text{s})/N$ (where N is the $\times N$ speed). The following table shows the measurement range when N is 1, 2, 4, 8, 16, and 32.

N	Measurement Range (Unit: μs)
1	78.730 to 238.730
2	39.365 to 119.365
4	19.682 to 59.682
8	9.841 to 29.841
16	4.920 to 14.920
32	2.460 to 7.460



* Truncate values below the one-thousandths place.

• Manual setting of $\times N$ speed

Specify the $\times N$ speed value N. When the value can be specified, the SET indicator lights and the $\times N$ speed value N is shown on the display.

- Range: 1.0 to 32.0
- Resolution: 0.1

• Selecting the polarity of the BI-PHASE signal

- : Measures the positive side (from the rising slope to the next falling slope) of the pulse width.
- : Measures the negative side (from the falling slope to the next rising slope) of the pulse width.

3. Setting the DC Output during BI-PHASE Measurement

This section describes the procedure for setting the DC output when the measurement function is set to BI-PHASE jitter.

Connecting the Cable

Connect a BNC cable to the DC output connector (JITTER DC OUT) on the rear panel of the TA120F.

Keys

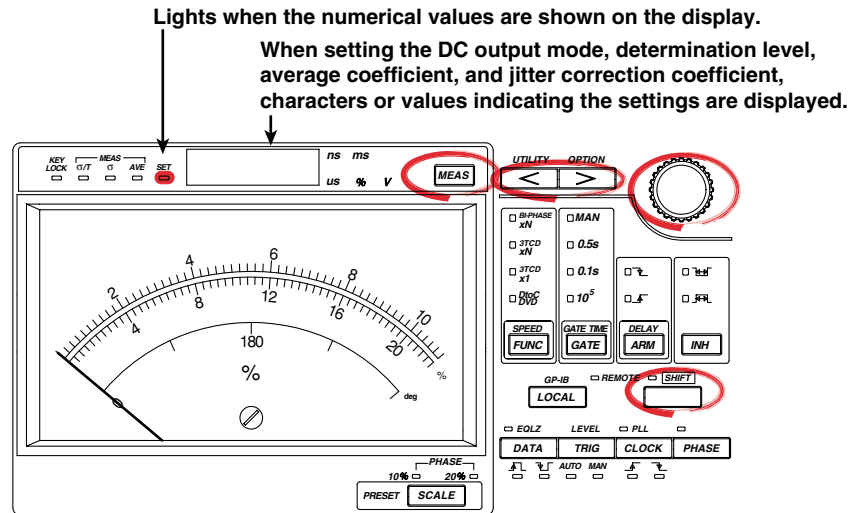

Procedure

Selecting the DC output mode

1. Press **SHIFT+<(UTILITY)**. The display shows the characters init.
2. Turn the **rotary knob** to select dcout.
3. Press **>**. Turn the **rotary knob** to select Jitt or JudGE. If you select Jitt (BI-PHASE jitter output), a DC voltage corresponding to the BI-PHASE jitter is output from the jitter DC output connector. If you select JudGE (determination output), a DC voltage of 5 V is output when the BI-PHASE jitter is below the determination level and 0 V when the jitter is above the determination level from the jitter DC output connector.

Setting the determination level

4. Press **SHIFT+<(UTILITY)**. The display shows the characters init.
5. Turn the **rotary knob** to select dcJdG.
6. Press **>**. The display shows the determination level of the BI-PHASE jitter.
7. Use the **rotary knob** and **arrow (< or >)** keys to set the determination level. For the procedure to set numeric values, see section 3.7 in the TA120F Digital Jitter Meter User's Manual (IM704430-01E).

Setting the average coefficient of the DC output filter

8. Press **SHIFT+<(UTILITY)**. The display shows the characters init.
9. Turn the **rotary knob** to select AVE.
10. Press **>**. The display shows the average coefficient of the DC output filter.
11. Use the **rotary knob** and **arrow (< or >)** keys to set the average coefficient. For the procedure to set numeric values, see section 3.7 in the TA120F Digital Jitter Meter User's Manual (IM704430-01E).

Setting the jitter correction coefficient α

12. Press **SHIFT+<(UTILITY)**. The display shows the characters init.
13. Turn the **rotary knob** to select ALPHA.
14. Press **>**. The display shows the correction coefficient α of the BI-PHASE jitter.
15. Use the **rotary knob** and **arrow (< or >)** keys to set the jitter correction coefficient α .
For the procedure to set numeric values, see section 3.7 in the TA120F Digital Jitter Meter User's Manual (IM704430-01E).

Setting the jitter correction coefficient β

16. Press **SHIFT+<(UTILITY)**. The display shows the characters init.
17. Turn the **rotary knob** to select bEtA.
18. Press **>**. The display shows the correction coefficient β of the BI-PHASE jitter.
19. Use the **rotary knob** and **arrow (< or >)** keys to set the jitter correction coefficient β .
For the procedure to set numeric values, see section 3.7 in the TA120F Digital Jitter Meter User's Manual (IM704430-01E).

If you press MEAS in the middle or at the end of the setting operation, the information that is specified up to that point is applied to the DC output setting and the measurement operation resumes.

Explanation

Setup menu of the BI-PHASE function

The following parameters are specified for the BI-PHASE function. Use **SHIFT+<(UTILITY)** and the rotary knob to select the parameter you wish to set.

- dcout:** Selects the DC output mode
dcJdG: Sets the determination level
AVE: Sets the average coefficient of the DC output filter
ALPHA: Sets the jitter correction coefficient α
bEtA: Sets the jitter correction coefficient β

Selecting the DC output mode

Select the DC output mode from the following:

- **Jitt (jitter output)**

The BI-PHASE jitter can be converted to DC voltage (0 V to 5 V) and output from the DC output connector on the rear panel. The following equation expresses the relationship between the DC output voltage DCV and the BI-PHASE jitter σ . However, the maximum DC output voltage is 5 V. 5 V is output for calculated results that exceed 5 V.

$$\text{DCV [V]} = \frac{5 \text{ [V]}}{\frac{150 \text{ [\mu s]}}{N}} \times \sigma \text{ [\mu s]} \quad \begin{array}{l} N: \times N \text{ speed value} \\ \sigma: \text{ Bi-Phase jitter} \end{array}$$

- **JudGE (determination output)**

Same as the standard product. For setting the determination level, see "Setting the determination level" described later.

- **DC output circuit**

Same as the standard product.

Setting the determination level

You can set the determination level for the determination output.

- Range: 0.000 μ s to 32.000 μ s
- Resolution: 0.001 μ s

Setting the average coefficient of the DC output filter

Same as the standard product. You can set the average coefficient (number of measured values to be averaged) when performing moving average. The filter specified for each measurement function is applied.

Setting the jitter correction coefficient

This function makes corrections to the measured jitter. The jitter ratio is the value obtained by dividing the corrected jitter ratio by the clock value (T). The corrected jitter is used for the numeric display, meter display, and DC output.

Correction equation: Corrected jitter (μ s) = correction coefficient α \times measured jitter (μ s) + correction coefficient β (μ s)

Corrected jitter ratio = corrected jitter/T*

*T: Period of the BI-PHASE clock ((158.730 μ s)/N (where N is the \times N speed))

- Selectable Range

Correction coefficient α : 0.0001 to 9.9999

Correction coefficient β : -9.999 μ s to 9.999 μ s

- Resolution

Correction coefficient α : 0.0001

Correction coefficient β : 0.001 μ s

Note

- When the average coefficient of the DC output filter is some value other than the initial value, the AVE (when displaying the average value) measurement indicator blinks.
 - When the average coefficient or the jitter correction coefficient is some value other than the initial value, the σ/T (when displaying the jitter ratio) or σ (when displaying the jitter) measurement indicator blinks.
 - The DC output is 5 V when the trigger is not activated for the input signal and measurements cannot be made.
-

4. Setting the Level Measurement Output

Connecting the Cable

Connect a BNC cable to the level measurement DC output connector (LEVEL DC OUT) on the rear panel of the TA120F.

Keys

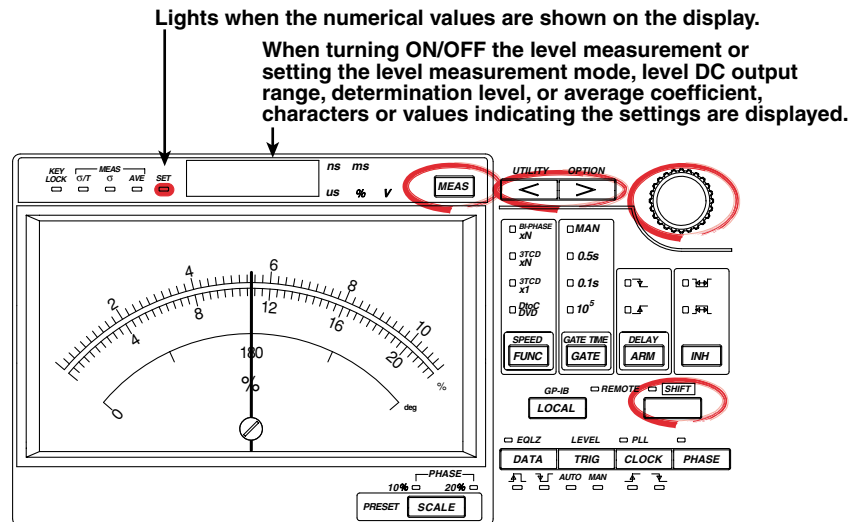

Procedure

Selecting the measurement function

1. Press **FUNC** to select 3T jitter, D-to-C jitter, or BI-PHASE jitter (option).
For details in setting 3T jitter and D-to-C jitter, see section 4.1 in the TA120F Digital Jitter Meter User's Manual (IM704430-01E). For details in setting the BI-PHASE jitter (option), see section 2 in this manual.

Turning ON/OFF the level measurement

2. Press **SHIFT+>(OPTION)**. The display shows the characters PP oP.
3. Press **>**. Turn the **rotary knob** to select on or OFF.
Select on to turn ON the level measurement mode. Level measurement is performed along with the jitter measurement. To show the level measurement value on the display, press **MEAS** and light the σ/T and σ indicator simultaneously. Select OFF to turn OFF the level measurement mode. Only the jitter measurement is performed.

Note

If you switch to the level measurement display when the level measurement is OFF, the display shows "----."

Selecting the level measurement mode

4. Press **SHIFT+>(OPTION)**. The display shows the characters PP oP.
5. Turn the **rotary knob** to select PPout.
6. Press **>**. Turn the **rotary knob** to select LEVEL or JudGE. If you select LEVEL (P-P voltage level output), the measured P-P voltage level is output from the level measurement DC output connector. If you select JudGE (level determination output), a DC voltage of 5 V is output when the measured level is within the determination level and 0 V when the measured level is outside the determination level from the level DC output connector.

Setting the level measurement output range

- **Setting the upper limit of the level measurement output range**

7. Press **SHIFT+>(OPTION)**. The display shows the characters PP oP.
8. Turn the **rotary knob** to select PP hi.
9. Press **>**. The display shows the upper limit of the level measurement output range.
10. Use the **rotary knob** and **arrow (< or >)** keys to set the upper limit.
For the procedure to set numeric values, see section 3.7 in the TA120F Digital Jitter Meter User's Manual (IM704430-01E).

- **Setting the lower limit of the level measurement output range**

11. Press **SHIFT+>(OPTION)**. The display shows the characters PP oP.
12. Turn the **rotary knob** to select PP Lo.
13. Press **>**. The display shows the lower limit of the level measurement output range.
14. Use the **rotary knob** and **arrow (< or >)** keys to set the lower limit.
For the procedure to set numeric values, see section 3.7 in the TA120F Digital Jitter Meter User's Manual (IM704430-01E).

Setting the determination level

- **Setting the upper limit of the determination level**

15. Press **SHIFT+>(OPTION)**. The display shows the characters PP oP.
16. Turn the **rotary knob** to select PP JH.
17. Press **>**. The display shows the determination level.
18. Use the **rotary knob** and **arrow (< or >)** keys to set the determination level.
For the procedure to set numeric values, see section 3.7 in the TA120F Digital Jitter Meter User's Manual (IM704430-01E).

- **Setting the lower limit of the determination level**

19. Press **SHIFT+>(OPTION)**. The display shows the characters PP oP.
20. Turn the **rotary knob** to select PP JL.
21. Press **>**. The display shows the determination level.
22. Use the **rotary knob** and **arrow (< or >)** keys to set the determination level.
For the procedure to set numeric values, see section 3.7 in the TA120F Digital Jitter Meter User's Manual (IM704430-01E).

Setting the average coefficient of the level measurement output filter

23. Press **SHIFT+>(OPTION)**. The display shows the characters PP oP.
24. Turn the **rotary knob** to select PPAVE.
25. Press **>**. The display shows the average coefficient of the level measurement output filter.
26. Use the **rotary knob** and **arrow (< or >)** keys to set the average coefficient.
For the procedure to set numeric values, see section 3.7 in the TA120F Digital Jitter Meter User's Manual (IM704430-01E).

If you press **MEAS** in the middle or at the end of the setting operation, the information that is specified up to that point is applied to the level DC output setting and the measurement operation resumes.

Explanation

Setup menu of level measurement

The following parameters are specified for the level measurement function. Use SHIFT+>(OPTION) and the rotary knob to select the parameter you wish to set.

PP oP: Turns ON/OFF the level measurement function

PPout: Selects the level measurement mode

PP hi: Sets the upper limit of the level measurement output range

PP Lo: Sets the lower limit of the level measurement output range

PP JH: Sets the upper limit of the level measurement determination

PP JL: Sets the lower limit of the level measurement determination

PPAVE: Sets the average coefficient of the level measurement output filter

Turning ON/OFF of the level measurement function

Turns ON/OFF of the level measurement function.

Selecting the level measurement mode

Selects whether to output the level measurement value or the determination output from the level measurement output connector on the rear panel.

- **LEVEL (level measurement output)**

The measured level of the selected measurement function can be converted to DC voltage (0 V to 5 V) and output from the level measurement DC output connector (LEVEL DC OUT) on the rear panel. You can specify the level that will output 5 V (upper limit) and the level that will output 0 V (lower limit), and output DC voltage that is proportional to the measured level. 5 V is output for calculated results that exceed 5 V. For setting the upper and lower limits, see “Setting the level measurement output range” described later.

When the upper limit is set to 5 V and the lower limit to 1 V

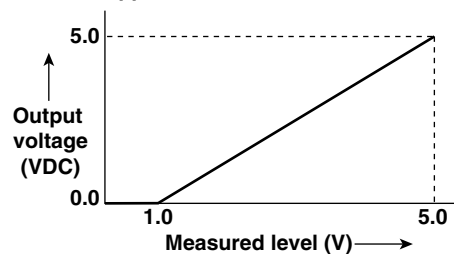

For the update rate of the level measurement output, see the note in section 4.4, “Setting the Gate” in the TA120F User’s Manual (IM704430-01E).

- **JudGE (determination output)**

You can judge the measured level against a specified value (determination level). If the level is within the determination level, a DC voltage of 5 V is output from the level DC output connector. When the level is outside the determination level, 0 V is output. For setting the determination level, see “Setting the determination level” described later.

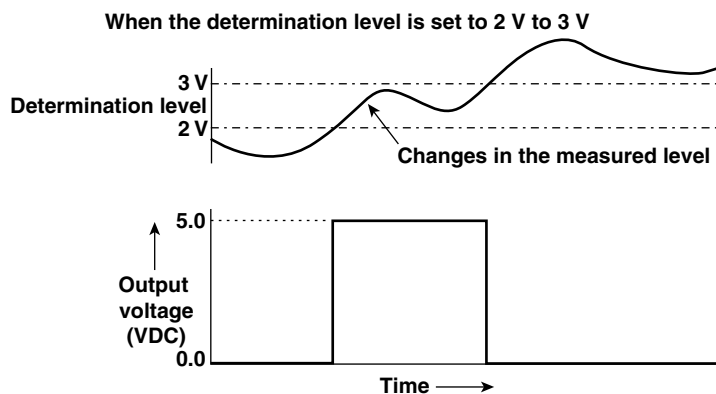

- **Level measurement DC output circuit**

Item	Specification
Output impedance	50 Ω (typical value*)
Output level	0 V to 5 VDC, given that the monitor equipment receives the signal at high impedance (approx. 1 MΩ).

* The typical value is a representative or standard value. It is not strictly guaranteed.

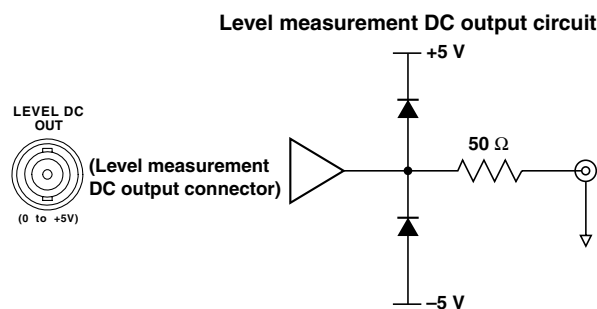

CAUTION

Do not apply external voltage to the output connector. This may cause damage to the TA120F.

- **Setting the level measurement output range**

Sets the upper and lower limits of the level measurement output range. The upper and lower limits correspond to 5 VDC and 0 VDC, respectively.

- Range: 0.000 to 15.000 V
- Resolution: 0.001 V

Setting the determination level

Sets the upper and lower limits of the level measurement determination output. 5 V is output when the measured level is lower limit \leq measured value \leq 0 V is output otherwise.

- Range: 0.000 to 15.000 V
- Resolution: 0.001 V

Setting the average coefficient of the level measurement DC output filter

Takes the moving average of the P-P voltage value that has been measured. When the DC output fluctuates due to instability in the measured P-P voltage, this function suppresses the degree of fluctuation. You can set the average coefficient (number of measured values to be averaged) when performing moving average. The P-P voltage that is moving-averaged using the DC output filter is applied to both the level measurement output and the determination output.

Range: 1 to 10 (moving average is not performed when 1 is specified)

Note

- If you set the lower limit to a value less than the upper limit in the level measurement output range setting, the upper limit is set equal to the lower limit.
 - If you set the upper limit to a value less than the lower limit in the level measurement determination level setting, the upper limit is set equal to the lower limit.
 - If you display the measured level when the average coefficient of the level measurement DC output filter is some value other than the initial value, the σ/T and σ measurement indicators blink.
-

5. Communication Commands

Due to the addition of the option functions, the following commands have been added or modified.

Commands for the BI-PHASE Measurement Function DCOut Group

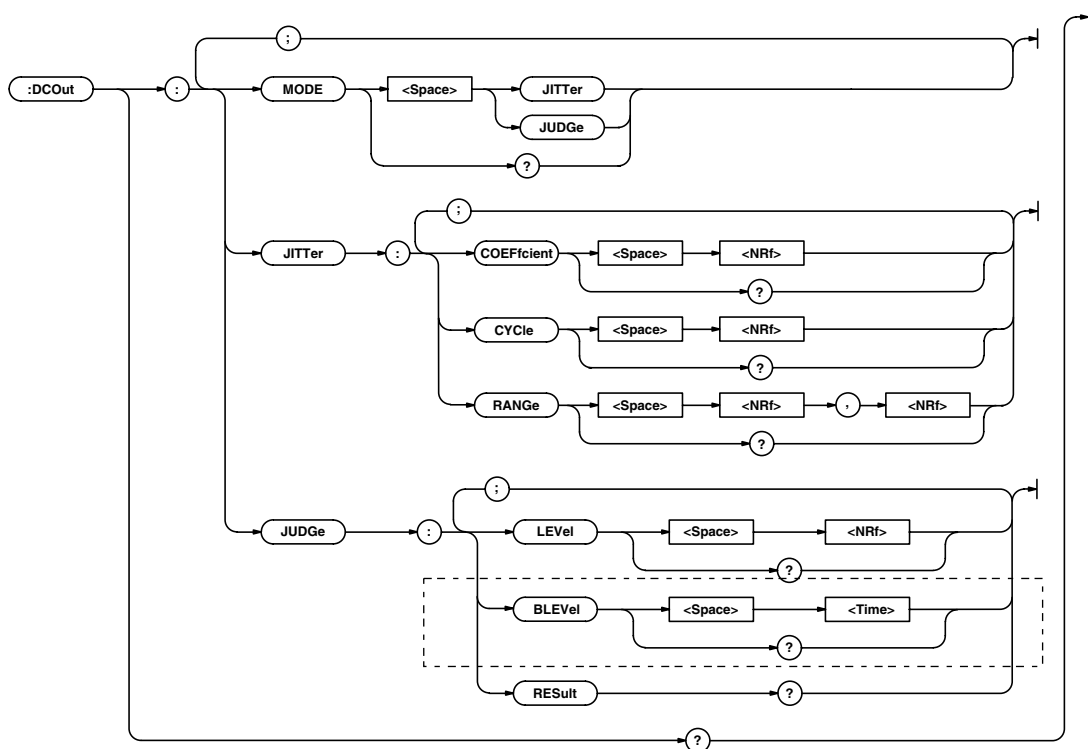

The section enclosed with [] indicates commands that have been added.

:DCOut : JUDGe : BLEVel

Function Sets the determination level when the measurement function is set to WOBBle (BI-PHASE jitter) or queries the current setting.

Syntax :DCOut:JUDGe:BLEVel {<Time>}

:DCOut:JUDGe:BLEVel?

<Time>=0.000 to 32.000ms (in 0.001 μ s steps)

Example :DCOUT:JUDGE:BLEVEL 16US

:DCOUT:JUDGE:BLEVEL? -> 16.000E-06

Description This command can be used only when the measurement function is set to "WOBBle" (BI-PHASE jitter).

MEASure Group

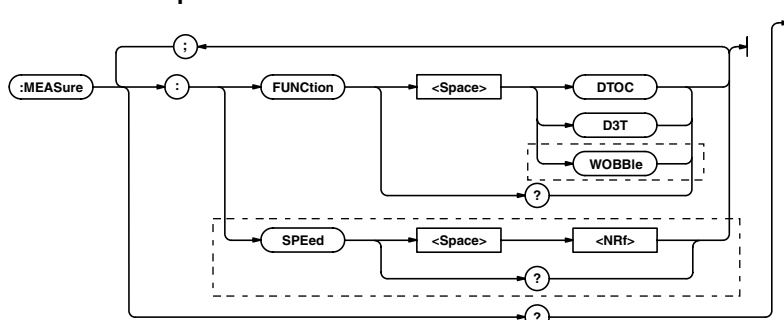

The section enclosed with [] indicates commands that have been added.

:MEASure:FUNCTION

Function Sets the measurement function or queries the current setting.

Syntax :MEASure:FUNCTION {DTCO|D3T|WOBBle}

:MEASure:FUNCTION?

- DTCO: D-to-C jitter
- D3T: 3T jitter
- WOBBle: BI-PHASE jitter

Example :MEASURE:FUNCTION WOBBle

:MEASURE:FUNCTION? -> :MEASURE:FUNCTION WOBBle

:MEASure:SPEEd

Function Sets the xN speed or queries the current setting.

Syntax :MEASure:SPEEd <Nrf>

:MEASure:SPEEd?

- <Nrf>=1.0 to 10.0 when the measurement function is set to "D3T."
- <Nrf>=1.0 to 32.0 (in 0.1 steps) when the measurement function is set to "WOBBle" (BI-PHASE jitter).

Example :MEASURE:SPEED 1.0

:MEASURE:SPEED? -> :MEASURE:SPEED 1.0E+00

Description This command cannot be used when the measurement function is set to "DTCO."

Commands for the Level Measurement Function

CALCulation Group

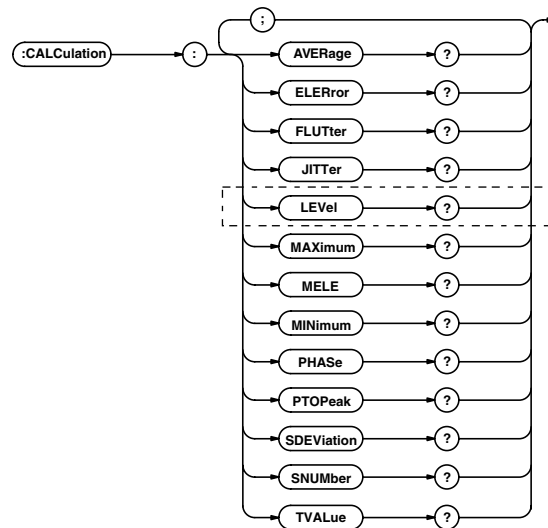

The section enclosed with  indicates commands that have been added.

:CALCulation:LEVel

Function Queries the P-P voltage of the level measurement.

Syntax :CALCulation:LEVel?

Example :CALCULATION:LEVel? -> 1.254E+0

Description If the statistical value is not valid, "9.999E+1" is returned.

DISPlay Group

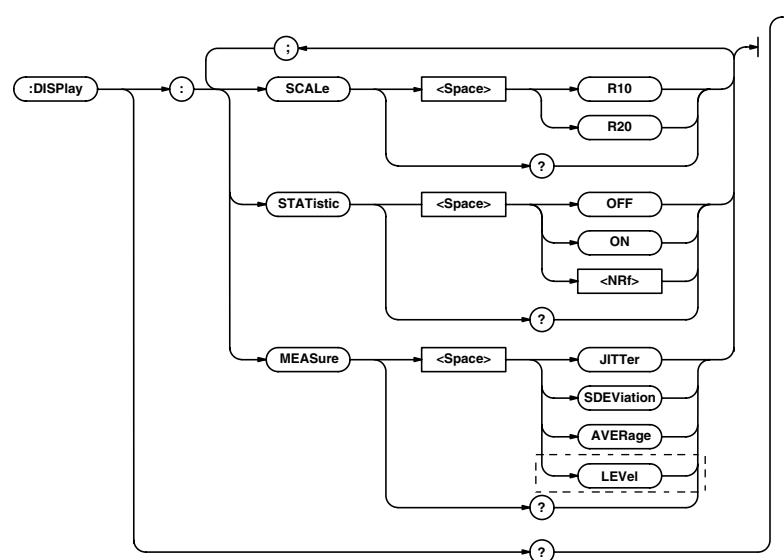

The section enclosed with  indicates commands that have been added.

:DISPlay:MEASure

Function Sets the statistic (jitter ratio, jitter, average value, P-P voltage) to be displayed numerically or queries the current setting.

Syntax :DISPlay:MEASure {JITTer|SDEViation|AVERage|LEVel}
:DISPlay:MEASure?

Example :DISPLAY:MEASURE LEVel
:DISPLAY:MEASURE? -> :DISPLAY:MEASURE LEVel

PPOut Group

The commands in this group deal with level measurement settings.

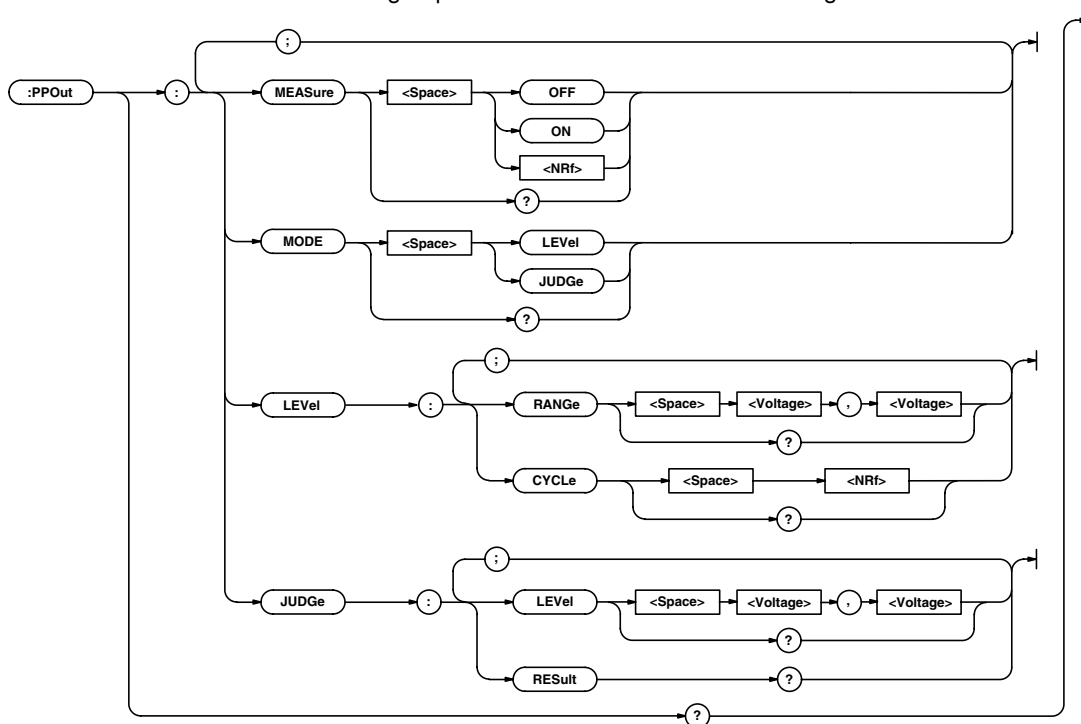

:PPOut:MEASure

Function Turns ON/OFF the level measurement or queries the current setting.

Syntax PPOut:MEASure {<Boolean>}

:PPOut:MEASure?

Example :PPOUT:MEASURE ON

:PPOUT:MEASURE? -> :PPOUT:MEASURE 1

:PPOut:MODE

Function Sets the level measurement output mode or queries the current setting.

Syntax :PPOut:MODE {LEVel|JUDGe}

:PPOut:MODE?

Example :PPOUT:MODE LEVEL

:PPOUT:MODE? -> :PPOUT:MODE LEVEL

Description This command can be used only when PPOut:MEASure is "ON."

:PPOut:LEVel:CYCLe

Function Sets the average coefficient (number of measured values to be averaged) of the level measurement output filter or queries the current setting.

Syntax :PPOut:LEVel:CYCLe <NRf>

:PPOut:LEVel:CYCLe?

<NRf>=1 to 10 (in 1 steps)

Example :PPOUT:LEVEL:CYCLE 1

:PPOUT:LEVEL:CYCLE? -> 1

:PPOut:LEVel:RANGe

Function Sets the upper and lower limits of the level measurement output range or queries the current setting.

Syntax :PPOut:LEVel:RANGe {<Voltage>},{<Voltage>}
:PPOut:LEVel:RANGe?

First parameter <Voltage>=0.000V to 15.000V (in 0.001 V steps)

Second parameter <Voltage>=0.000V to 15.000V (in 0.001 V steps)

The first and second parameters are upper and lower limits, respectively. If the upper limit is less than the lower limit, an error occurs.

Example :PPOut:LEVel:RANGe 15.000,0.000
:PPOut:LEVel:RANGe? -> 15.000E+00,0.000E+00

Description This command can be used only when PPOut:MEASure is "ON."

:PPOut:JUDGe:LEVel

Function Sets the upper and lower limits of the determination level of the level measurement output or queries the current setting.

Syntax :PPOut:JUDGe:LEVel {<Voltage>},{<Voltage>}
:PPOut:JUDGe:LEVel?

First parameter <Voltage>=0.000V to 15.000V (in 0.001 V steps)

Second parameter <Voltage>=0.000V to 15.000V (in 0.001 V steps)

The first and second parameters are upper and lower limits, respectively. If the upper limit is less than the lower limit, an error occurs.

Example :PPOut:JUDGe:LEVel 3.000,1.000
:PPOut:JUDGe:LEVel? -> 3.000E+00,1.000E+00

Description This command can be used only when PPOut:MEASure is "ON."

:PPOut:JUDGe:RESult?

Function Queries the determination result of the level measurement output.

Syntax :PPOut:JUDGe:RESult?

Example :PPOut:JUDGe:RESult? -> NOGO

Description This command can be used only when PPOut:MEASure is "ON."
The result is returned as "GO" or "NOGO."

6. Connection to the EXT I/O Terminal



CAUTION

Applying a voltage/current that exceeds the allowable input voltage range/ maximum output current to the EXT I/O terminal may damage the I/O section.

This terminal can be used to recall the setup information from the memory and output the determination result of the jitter DC output and level measurement (See section 4, “Setting the Level Measurement Output” (option)). Use the “EXT I/O D-sub connector” that came with the package to connect to the EXT I/O connector.

Item	Specification
Connector	9-pin D-sub connector (female)
Input impedance	10 k Ω (typical value*)
Output impedance	600 Ω (typical value*)
I/O level	TTL
Allowable input voltage range	-5 V to 10 V (DC+ACpeak)
Maximum output current	± 20 mA

* The typical value is a representative or standard value. It is not strictly guaranteed.

Pin arrangement of the EXT I/O terminal (female)

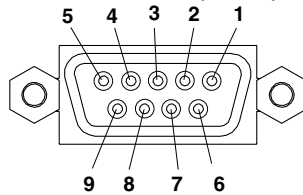

EXT I/O D-sub connector included in the package (male)

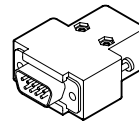

Pin Assignments

Pin No.	Signal Name	I/O	Note	INPUT LEVEL*
1	ENABLE	IN	Enables the EXTERNAL I/O	0: Enable 1: Disable
2	RECALL0	IN	Read the setup information stored in the memory using 3 bits, No. 2 to 4.	No.432 setup condition
3	RECALL1	IN		111 Keep the panel settings
4	RECALL2	IN		110 Recall 6 101 Recall 5 : : 000 Recall 0
5	Reserved	IN		
6	Reserved	IN		
7	PEAK JUDGE	OUT	Outputs the determination value specified by 1: Go, 0: NoGo the level measurement determination output	
8	JITTER JUDGE	OUT	Outputs the determination value specified by the jitter determination output	1: Go, 0: NoGo
9	GND	GND	GND	

* INPUT LEVEL is TTL LOW level and TTL HIGH level for 0 and 1, respectively.

Note

- The input terminal is internally connected to a pull-up resistor. Thus, 1 is output for OPEN.
- When the ENABLE terminal is set to disable, the output terminal outputs a signal that corresponds to NoGo (outside the determination level) that is specified by the determination output.
- You cannot control the TA120F via the EXT I/O connector and GP-IB interface, simultaneously.

7. Performance Tests

Level Measurement Test

Items Required

The following items are required.

- **Digital multimeter**
Recommended device: Digital Multimeter 7562 (YOKOGAWA)
- **Function generator**
Recommended instrument: Synthesized function generator FG300 (YOKOGAWA)
- **Thermal converter**
Recommended device: 1395A-1-09 (Ballantine)

The procedure for testing the level measurement using the recommended instrument is described below.

Connecting the instrument

- Check that the power switch is turned OFF on all instruments before connecting the instruments. Do not connect the output of the function generator to the thermal converter at this point.
- Set the output of the function generator to 1 V_{P-P} (50 Ω load) and the offset to 0 V.
- Then, connect the function generator to the other end of the T branch of the thermal converter input.

Figure A

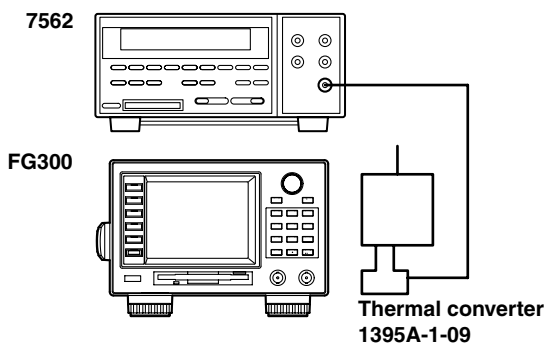

Figure B

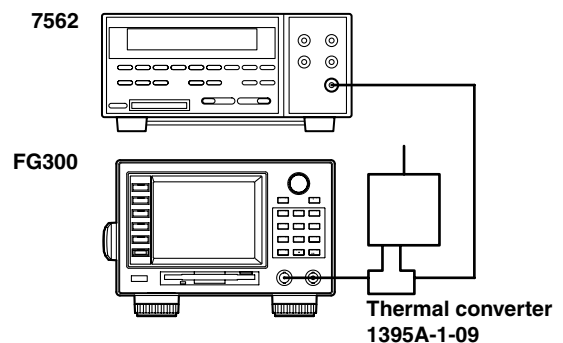
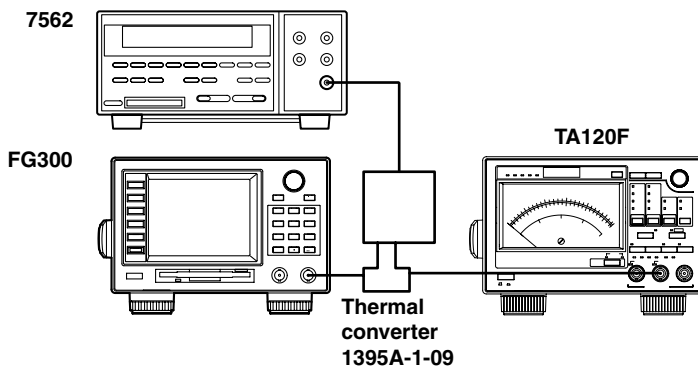



Figure C



Instrument settings

TA120F

- Measurement function: D-to-C
- Slope of the data signal: 
- Slope of the clock signal: 
- Gate: 0.1 s
- Trigger mode: MAN
- Slice level: 0.000 V
- Phase difference: 0.0 ns

7562

- Function: DCV/ACV
- Range: AUTO
- Sample mode: AUTO
- Integration time: 100 ms
- Sampling interval: 500 ms
- Delay: 0
- Average: OFF

FG300

- Output frequency: 1 kHz, 100 kHz
- Output voltage amplitude: 2 V_{P-P}
- Phase: 0.0 deg
- Offset voltage: 0.0 V
- Output attenuator: 1/1
- Output waveform: sine wave

Test method

- Test the TA120F after 30 minutes of warm-up.
- In this test, 1 V_{P-P} signal (50-Ω load) of which the amplitude has been calibrated is applied and the level is measured. The input signal is compared with the measured level to test the level measurement error.

Test procedure

1. As shown in figure A, connect the digital multimeter to the thermal converter via the T branch.
In this condition, set the output waveform of the function generator as follows:
Output frequency: 1 kHz
Output voltage amplitude: 2 V_{P-P}
Phase: 0.0 deg
Offset voltage: 0.0 V
Output attenuator: 1/1
Output waveform: sine wave
2. As shown in figure B, connect the output of the function generator to the thermal converter via the T branch. Measure the AC signal using the digital multimeter and adjust the amplitude of the function generator so that the measured value reads 353.55 vrms±1 mVrms.

-
3. As shown in figure C, connect the section that was connected to the digital multimeter to the TA120F via the T branch of the thermal converter input. Next, connect the thermal converter output to the digital multimeter. Switch the digital multimeter to DC measurement and measure and record the value.

 4. Switch the frequency of the function generator to 100 kHz and measure the DC signal on the digital multimeter. Adjust the amplitude of the function generator to match the value of the digital multimeter that was recorded.
 The adjustment range is $\pm 2\%$ of the digital multimeter value that was recorded in step 3.
 Perform level measurement on the TA120F in this condition.

Test result

7562 Measured DC Value	FG300 Amplitude Setting	TA120F Measured Level	Allowable Range
mV	V _{P-P}	V _{P-P}	1.060 V to 0.940 V

8. Specifications

The specifications related to the options are indicated below. All other specifications are the same as the standard product.

BI-PHASE Measurement Function Specification

Item	Specification
Number of channels	3 (Add one BI-PHASE input connector to the standard product.)
Maximum sample rate	During BI-PHASE jitter measurement: 5 MS/s (200 ns interval) continuous
Internal jitter* ^{1, 2}	During BI-PHASE jitter measurement: 300 psrms
BI-PHASE input	
Connector type	BNC
Coupling	DC
Input impedance	1 MΩ, 35 pF (typical value* ³)
Maximum input voltage	DC ≤ frequency of the input signal ≤ 100 kHz: 40 V (DC+ACpeak)
Input sensitivity* ¹	100 mV _{P-P}
Input range	−5 V to +5 V
Trigger	Trigger mode: Manual mode only. Trigger slope: Select \uparrow or \downarrow . Range: −5.000 V to 5.000 V Resolution: 1 mV Accuracy* ¹ : ±(4% of the specified value + 10 mV)
Measurement function	
BI-PHASE jitter	×N speed can be specified. • Range: 1.0 to 32.0 • Resolution: 0.1 Range: (158.730±80.000 μs)/N, where N is the ×N speed.
Statistics display	Select from jitter ratio, jitter, and average value.
Average measurement	Accuracy: ±(300 psrms + trigger level timing error + (time base frequency stability × measured value) + 1 ns systematic error)
Resolution of the display	
	μs unit When numerically displaying the BI-PHASE jitter (σ): 0.001 μs When numerically displaying the BI-PHASE average (AVE): 0.01 μs
JITTER DC output (specifications regarding the BI-PHASE jitter are indicated)	
	Conversion equation to DC voltage DCV
	$DCV [V] = \frac{5 [V]}{150 [\mu s]} \times \sigma [\mu s] \times \frac{1}{N}$
	N: ×N speed value σ: Bi-Phase jitter
	* 5 V is output for calculated results that exceed 5 V.
	Determination output Range of determination level: 0.000 μs to 32.000 μs, resolution: 0.001 μs

*1 Measured value under standard operating conditions as described in General Specifications (see the TA120F User's Manual (IM704430-01E)) after the warm-up time has elapsed.

*2 Value excluding the trigger error and trigger level timing error.

- Trigger error

$$\frac{\sqrt{X^2 + E_n^2}}{S.R}$$

X: Signal noise (400 μV_{rms}) within the input amplifier bandwidth (100 MHz)
E_n: Noise in the signal being measured
S.R: Slew rate of the signal being measured

- Trigger level timing error

$$\pm \left(\frac{15mV}{\text{Slew rate of the start signal}} - \frac{15mV}{\text{Slew rate of the stop signal}} \right) \pm \frac{\text{Trigger level setting accuracy}}{\text{Slew rate of the start signal}} \pm \frac{\text{Trigger level setting accuracy}}{\text{Slew rate of the stop signal}}$$

*3 The typical value is a representative or standard value. It is not strictly guaranteed.

Level Measurement Function Specifications

Item	Specification
Measurement method	Maximum amplitude of the RF input or the BI-PHASE input (option)
Level measurement ON/OFF function	ON/OFF of Level measurement can be switched. Level measurement possible only when turned ON.
Measurement range	For RF input When the equalizer is ON or the trigger mode is set to auto or auto + manual: 100 mV _{P-P} to 4 V _{P-P} When the equalizer is OFF and the trigger mode is set to manual: 100 mV _{P-P} to 5 V _{P-P} For BI-PHASE input 100 mV to 5 V _{P-P}
Accuracy ^{*3}	±(5% + 10mV) (when 1-V _{P-P} , 100-kHz sine wave is measured)
Frequency characteristics (-3 dB point)	2.5 MHz (typical value ^{*1})
Display resolution	0.001 V
Measurement update rate	Time to measure the level (approx. 44 ms) + minimum jitter measurement time (50 ms) (when measuring a 8-16 modulated signal with the measurement function set to D-to-C jitter and the gate type set to event gate)
Level measurement DC output	
Connector type	BNC
Output impedance	50 Ω (typical value ^{*1})
Output coupling	DC
Output level	0 V to 5 VDC (under high impedance load)
Output mode	Select level output or determination output.
Output filter	Range of average coefficient: 1 to 10
Level output range	Range: 0.000 V to 15.000 V, resolution: 0.001 V
Determination output	Range of determination level: 0.000 V to 15.000 V, resolution: 0.001 V
Output level ^{*2}	0 V to 5 VDC (under high impedance load) Conversion equation to DC voltage DCV $DCV [V] = \frac{5 [V]}{V_H[V]-V_L[V]} \times V[V]$ V _H : Upper limit of the level output range V _L : Lower limit of the level output range V: Measured level
Output voltage accuracy ^{*2, *3}	* 5 V is output for calculated results that exceed 5 V. ±10 mV (under high-impedance load)

*1 The typical value is a representative or standard value. It is not strictly guaranteed.

*2 When the monitor equipment receives the signal at high impedance (approx. 1 MΩ).

*3 Measured value under standard operating conditions as described in General Specifications (see the TA120F User's Manual (IM704430-01E)) after the warm-up time has elapsed.

EXT I/O Specifications

Item	Specification
Connector type	9-pin D-sub connector (female)
Input impedance	10 kΩ (typical value ^{*1})
Output impedance	600 Ω (typical value ^{*1})
I/O level	TTL
Allowable input voltage range	-5 V to 10 V (DC+ACpeak)
Maximum output current	±20 mA

*1 The typical value is a representative or standard value. It is not strictly guaranteed.

Index

Symbols

×N 11

A

ALPHA 13
AVE 12
average coefficient (for BI-PHASE jitter) 14
average coefficient (for level measurement) 19
average value 4

B

bEtA 13
BI-PHASE jitter 11
BI-PHASE Measurement Test 26

C

CALCulation Group 22
correction coefficient 14

D

DC output circuit (for BI-PHASE jitter) 13
DC output circuit (for level measurement) 18
DC output filter (for BI-PHASE jitter) 4
DC output filter (for level measurement) 6
DC output mode 13
DC output of BI-PHASE jitter 4
DC output of the level measurement 6
dcJdG 12
dcout 12
DCOut Group 20
determination level (for BI-PHASE jitter) 14, 20
determination level (for level measurement) 19, 24
determination output (for BI-PHASE jitter) 13
determination output (for level measurement) 18
determination result (for EXT I/O terminal) 25
determination result (for level measurement) 24
DISPlay Group 22

E

EXT I/O 6, 25
External I/O Terminal 6

F

front panel 7

J

Jitt 12
jitter correction coefficient 14
Jitter determination 4
jitter output 13
jitter ratio σ/T 4
jitter σ 4
JudGE 12, 15

L

LEVEL 15
level measurement mode 17
level measurement output 17
level measurement test 26

M

MEASure Group 21

O

ON/OFF of the level measurement function 17
output range 18

P

polarity of the BI-PHASE signal 11
power switch 8
PP hi 16
PP JH 16
PP JL 16
PP Lo 16
PP oP 15
PPAVE 16
PPout 15
PPOut Group 23
pulse width 11

R

rear panel 8
recall 25

S

specifications 29
standard deviation σ 4
statistic 22

W

wobble 4, 20