

User's Manual

USB Compliance Test Fixture

This user's manual describes handling of the test fixture used for USB compliance tests. For USB compliance test procedures, software operating instructions, and other information, please refer to the following manuals.

Manual Name	Manual No.
USB Compliance Test Software (busXplorer-USB) User's Manual	IM701985-61E
Universal Serial Bus 2.0 Device Compliance Test Procedure (CD-ROM)	IM701985-62E
Universal Serial Bus 2.0 Host Compliance Test Procedure (CD-ROM)	IM701985-63E
Universal Serial Bus 2.0 Hub Compliance Test Procedure (CD-ROM)	IM701985-64E

For inquiries, please see PIM112-01E (attached).

3rd Edition : December 2008 (YK)
All Rights Reserved, Copyright © 2006, Yokogawa Electric Corporation



IM 701985-01E
3rd Edition

Safety Precautions

To ensure safe and correct operation of the fixture, you must take the safety precautions given below. The fixture's protective functions may not work if used in a manner not described in this manual. The test fixture is a dedicated instrument for the DL9240/DL9240L. Yokogawa bears no responsibility for, nor implies any warranty against damages occurring as a result of failure to take these precautions. The following safety symbols and wording are used on the test fixture.

Warning: handle with care. Refer to the user's manual or service manual. This symbol appears on dangerous locations on the instrument which require special instructions for proper handling or use. The same symbol appears in the corresponding place in the manual to identify those instructions.

Hot surface

Make sure to comply with the following safety precautions in order to prevent accidents such as an electric shock which impose serious health risks to the user and damage to the instrument.



WARNING

- To prevent shock or fires, only use the AC adapter and power cable supplied by Yokogawa specifically for the test fixture. Also, connect a power supply that meets the specifications of the AC adapter. Insert the power cable securely into the plug inlet on the AC adapter, and connect the output cable securely to the test fixture's power connector.

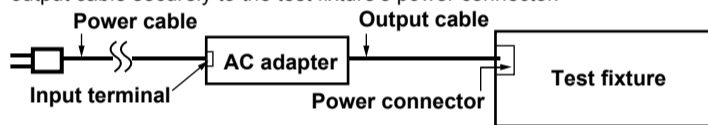

Never use an AC adapter or power cable other than the dedicated ones supplied by Yokogawa. Using the wrong adapter or cable can result in damage or injury. Also, never use the AC adapter that came with the test fixture for any other device.

- Do not allow any electrically conductive objects to come into contact with the bottom surface of the test fixture.
- Beware of exposed circuits. Due to the structure of the test fixture, certain components may be exposed. To prevent injury, remove all jewelry such as rings and wristwatches. Also, make sure not to touch any exposed connectors or components.
- Never insert your fingers between the metal plates in the center of the test fixture and the solder-side of the PCB.



CAUTION

- Do not inadvertently twist or pull the USB cable. The wires inside the cable can break, causing malfunction.
- When shipping or handling, support the test fixture by the center metal plates and avoid vibration and shock. Take extra care not to drop the test fixture. Also, never carry the test fixture by the USB cable.
- Due to the structure of the test fixture, certain components may be exposed. Take precautions against static electricity when handling.

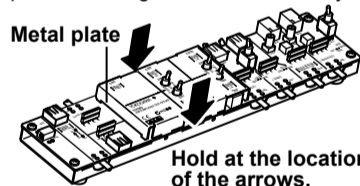

Operating environment limitations

See below for operating environment limitations.

CAUTION

This product is a Class A (for industrial environments) product. Operation of this product in a residential area may cause radio interference in which case the user will be required to correct the interference.

Waste Electrical and Electronic Equipment



Waste Electrical and Electronic Equipment (WEEE), Directive 2002/96/EC

(This directive is only valid in the EU.)

This product complies with the WEEE Directive (2002/96/EC) marking requirement. This marking indicates that you must not discard this electrical/electronic product in domestic household waste.

Product Category

With reference to the equipment types in the WEEE directive Annex 1, this product is classified as a "Monitoring and Control instrumentation" product.

Do not dispose in domestic household waste. When disposing products in the EU, contact your local Yokogawa Europe B. V. office.

The Following Symbols are Used in this Manual.



Improper handling or use can lead to injury to the user or damage to the instrument. This symbol appears on the instrument to indicate that the user must refer to the user's manual for special instructions. The same symbol appears in the corresponding place in the user's manual to identify those instructions. In the manual, the symbol is used in conjunction with the word "WARNING" or "CAUTION."

WARNING

Calls attention to actions or conditions that could cause serious or fatal injury to the user, and precautions that can be taken to prevent such occurrences.

CAUTION

Calls attentions to actions or conditions that could cause light injury to the user or damage to the instrument or the user's data, and precautions that can be taken to prevent such occurrences.

Note

Calls attention to information that is important for proper operation of the instrument.

1. Checking the Product

A name plate with the model name is located on the bottom surface (back side) of the test fixture. Confirm that the model on the name plate matches that of your order.

MODEL

Model	Suffix Code	Specification
701985		USB Compliance test fixture
Power cord	-D	UL/CSA Standard power cord (Part No.:A1068WD)
	-F	VDE Standard power cord (Part No.:A1071WD)
	-Q	BS Standard power cord (Part No.:A1069WD)
	-R	AS Standard power cord (Part No.:A1070WD)
Options	/F30	USB compliance software
	/MN1*	Mini B connector type test fixture

* When the /MN1 option is selected, cable CN25 of the DEVICE RECEIVER SENSITIVITY TEST block and cable CN31 of the DEVICE SQ TEST BLOCK will have mini b type connectors.

NO. (Instrument Number)

Please have this number ready when contacting your Yokogawa representative.

Note

For PC system requirements and other specifications, see "USB Compliance Test Software User's Manual" (IM701985-61E).

2. Product Overview

The test fixture is used together with the USB compliance test software to perform tests conforming to the USB 2.0 compliance test procedures. The fixture consists of separate test blocks for the following nine tests: DEVICE SQ TEST, HOST SQ TEST, DEVICE RECEIVER SENSITIVITY TEST, TRIGGER, INRUSH TEST, LOAD TEST, DROOP TEST, BACKDRIVE VOLTAGE TEST, AVERAGE CURRENT DRAW TEST. The test block used differs depending on the test. Waveforms can be observed by probing the measurement pins and waveform measurement connectors on the test fixture.

3. Names of Parts



CAUTION

- Take care when handling USB cables and the current measurement loop attached to the test fixture. Pulling strongly on cables can cause them to become detached from the test fixture.
- Do not forcefully press the measurement pins and waveform measurement connectors on the test fixture.

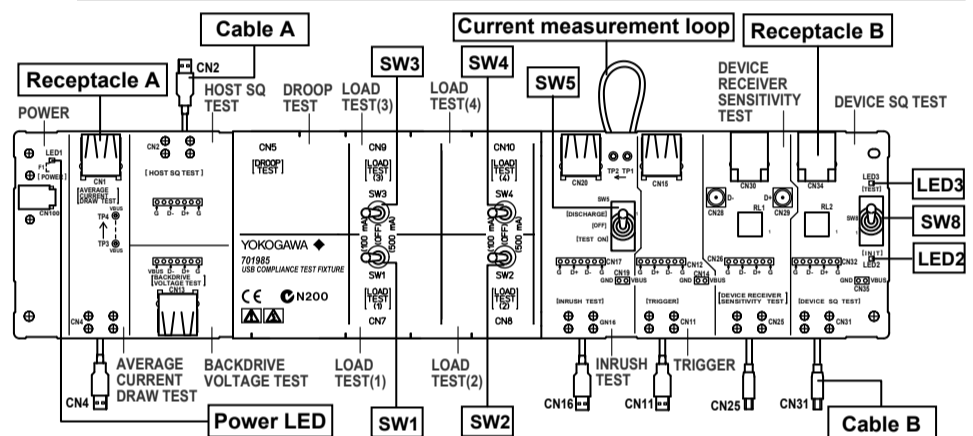

4. Usage Precautions

Safety Precautions

Do not remove the case

Do not remove the cover from the top of the test fixture or the case on the bottom. Load resistors inside the cover and adjacent components become dangerously hot.

In case of abnormalities

If there are any symptoms of trouble such as strange smells or smoke coming from the test fixture or AC adapter, remove the power cord from the outlet immediately. If abnormalities occur, please contact your nearest Yokogawa dealer or representative.

AC adapter and power cord

Nothing should be placed on top of the AC adapter or power cord. The AC adapter and power cord should also be kept away from heat sources. When removing the power cord plug from the outlet, always pull by the plug, never pull by the cord. When removing the AC adapter output cable from the test fixture, hold by the plug and pull straight out. Do not pull by the cord. If the cord is damaged, contact your dealer for replacement.

General Handling Precautions

Do not place anything on top of the test fixture

Never place other instruments or objects containing water on top of the test fixture. Doing so can lead to malfunction.

Do not apply shock to the test fixture

Never apply physical shocks to the connectors, switches, or other components.

Take proper care when carrying

Do not hold by the USB cable. Also, hold the test fixture firmly by the center metal plates, and do not drop the fixture.

Extended periods of non-use

Remove the power cord from the outlet.

Cleaning

When cleaning, remove the power cord from the outlet, then wipe gently with a soft, dry cloth. Also, never immerse the test fixture in liquid, nor use any detergents or abrasives. Do not use any volatile solvents such as benzene.

Installation Conditions

Install the fixture so that the following conditions are met.

- Flat horizontal location
- Well ventilated location
- Place the test fixture on a stable, horizontal surface. Also, always orient the fixture with the component side up.
- Maintain a gap of 10 cm or more on all sides of the test fixture.

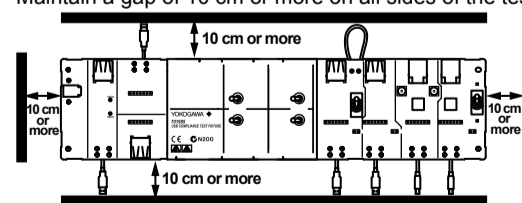

Do Not Install the Fixture in the Following Places

- In direct sunlight or near heat sources
- Where an excessive amount of soot, steam, dust, or corrosive gas is present
- Near strong magnetic field sources
- Near high voltages or power lines
- Location where mechanical vibration is high
- In an unstable place
- On an unlevelled surface

5. Test Blocks



WARNING

- If you set SW1 to SW4 to 500 mA when Vbus is supplying the LOAD TEST connectors (CN7 to CN9), the load resistors will become extremely hot. Make sure you do not touch the load resistors.
- Since the load resistors of the LOAD TEST blocks get hot during the Droop and Drop tests, after finishing these tests, immediately remove the USB cables connected to connectors CN7–CN10 and disconnect the Vbus power supply from the upstream port, or turn OFF SW1–SW4.

LOAD TEST

Four blocks (1 to 4) are available for the LOAD test. You can switch the load current between 100 mA, OFF, and 500 mA using the switch for each of the blocks (SW1 to SW4).

Block Name	Connector Used	Switch Used
LOAD TEST[1]	CN7 (receptacle B)	SW1 (100 mA/OFF/500 mA)
LOAD TEST[2]	CN8 (receptacle B)	SW2 (100 mA/OFF/500 mA)
LOAD TEST[3]	CN9 (receptacle B)	SW3 (100 mA/OFF/500 mA)
LOAD TEST[4]	CN10 (receptacle B)	SW4 (100 mA/OFF/500 mA)

Note

Supply a voltage of 5 V \pm 5% to Vbus.

DROOP TEST

Switches the load current between 0 mA and 100 mA at cycles of approximately 2 Hz. Connector used: CN5 (receptacle B)

INRUSH TEST

SW5 switches between TEST ON, OFF, and DISCHARGE.

When measuring the inrush current, attach a current probe to the current measurement loop. Cable and connector used: CN16 (cable A) and CN20 (receptacle A)

Note

Do not apply a current of 1 Arms or greater to Vbus.

TRIGGER

Cable and connector used: CN11 (cable A) and CN15 (receptacle A)

HOST SQ TEST

Cable used: CN2 (cable A)

DEVICE RECEIVER SENSITIVITY TEST

SW8 switches RL1(RL2) between INIT and TEST.

- When Set to INIT
The D+ and D– signals are routed between CN30 and CN25.
- When Set to TEST
The D+ signal is routed between CN29 and CN25, and the D– signal is routed between CN28 and CN25.

Vbus is always connected between CN25 and CN30 regardless of the SW8 setting.

Cable and connector used: CN25 (cable B, or mini B cable with the /MN1 option) and CN30 (receptacle B)

DEVICE SQ TEST

SW8 switches RL2 (RL1) between INIT and TEST.

- When Set to INIT
The D+ and D– signals are routed between CN34 and CN31.
- When Set to TEST
The D+ and D– signals are routed between CN31 and the 45 Ω terminator.

Vbus is always connected between CN31 and CN34 regardless of the SW8 setting.

Cable and connector used: CN31 (cable B, or mini B cable with the /MN1 option) and CN34 (receptacle B)

BACKDRIVE VOLTAGE TEST

Measure D+, D–, and Vbus voltage at CN18.

Connector used: CN13 (receptacle A)

AVERAGE CURRENT DRAW TEST

This test block is used for “Device Framework Testing.” Measure the Vbus current between TP3 and TP4.

For testing methods, see “C. Device Framework Testing” in the Universal Serial Bus Implementers Forum Full and Low Speed Electrical And Interoperability Compliance Test Procedure.

6. Preparing for Waveform Measurement

Affixing the Probe Attachment

- PBA2500 Active Probe (Model 701913, Sold Separately)
Affix the attachment (model B8080JP or B8080JQ) that came with the probe as shown in the diagram below.
- PBD2000 Active Probe (Model 701923, Sold Separately)
Affix the attachments (model B8080JP, 2 pcs.) that came with the probe as shown in the diagram below.

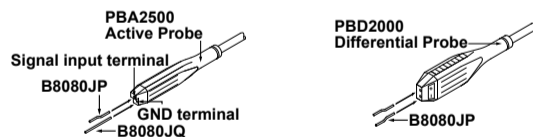

CAUTION

When inserting a probe with the attachment affixed into the waveform measurement connector, do not apply vibration or shock to the probe.

Waveform Measurement Connector

- As for the waveform measurement connectors (CN3, CN12, CN17, CN18, CN26, and CN32), insert the accessory connectors into the connectors already installed on the test fixture in a two-layer configuration. The connectors come in two layers upon shipment.

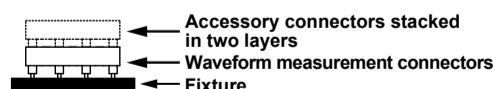

- Affix the dedicated attachments to the PBA2500 and PBD2000 probes, then insert into the specified pins of the second layer of connectors. For the locations and numbers of pins, see the procedure manuals for the individual tests.

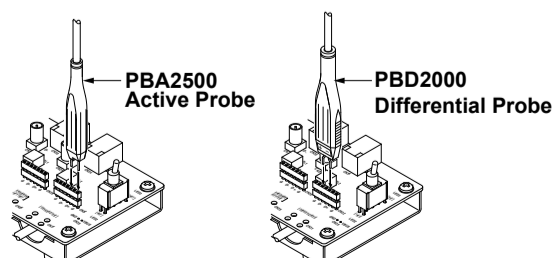

CAUTION

Do not insert anything into the waveform measurement connectors other than the PBA2500 or PBD2000 with dedicated attachments affixed, or the accessory sockets.

Note

Never pull out the top layer of connectors except when changing them.

7. Troubleshooting

Troubleshooting

If servicing is necessary, or if the fixture is not operating correctly after performing the corrective actions below, contact your nearest YOKOGAWA dealer.

Description	Possible Problem	Corrective Action
LED1, 2, or 3 does not turn ON.	Using an AC adapter of a voltage outside the rated range.	Use the AC adapter that came with the fixture.
	Faulty connection between the AC adapter and the CN100 connector of the test fixture.	Check the connection between the AC adapter and connector CN100 of the test fixture.
Trigger does not activate on the inrush current waveform.	SW5 not set to TEST ON.	Set SW5 to TEST ON when measuring.
The VID, PID, connected address, and port of the DUT (host/hub) are not displayed in the HS Electrical Test Tool.	SW8 not set to INIT.	Set SW8 to INIT.

8. Specification

Safety Standards

Conforming standards	EN61010-1 Overvoltage category (installation category) II* Pollution degree 2**
----------------------	---

* Overvoltage category (installation category) is a number that defines excessive voltage, and includes regulations for impulse withstand voltage. It applies to electrical equipment that is powered by a fixed installation such as a distribution board.

** Pollution degree refers to the degree of adherence by a solid, liquid, or vapor that reduces the withstand voltage or surface resistance factor. Pollution degree 2 applies to normal indoor atmospheres (with non-conductive pollution) only.

Emmissions

Conforming standards	EN61326-1 Class A EN61326-2-1 EN55011 Class A, Group 1 C-tick EN55011 Class A, Group 1
----------------------	---

This product is a Class A (for industrial environment) product. Operation of this product in a residential area may cause radio interference in which case the user is required to correct the interference.

Cable conditions

- Use a 5 m USB cable at CN20 (receptacle A) on the INRUSH TEST block.
- Use a 5 m USB cable at CN34 (receptacle B) on the DEVICE SQ TEST block.
- Use a 1 m USB cable at the A and B receptacles on the other TEST blocks.

Immunity

Conforming standards	EN61326-1 Table 2 (for use in industrial locations) EN61326-2-1
----------------------	--

Cable conditions

- Use a 5 m USB cable at CN20 (receptacle A) on the INRUSH TEST block.
- Use a 5 m USB cable at CN34 (receptacle B) on the DEVICE SQ TEST block.
- Use a 1 m USB cable at the A and B receptacles on the other TEST blocks.

Reference operating conditions	Ambient temperature	23°C \pm 5°C
	Ambient humidity	55 \pm 10% RH
	Error in supply voltage and frequency	Within 1% of rating
Storage Environment	Temperature	–20°C to 60°C
	Humidity	20% to 80% RH (no condensation)
Operating environment	Temperature	5°C to 40°C
	Humidity	20% to 80% RH (no condensation)
Storage altitude		3000 m or less
Operating altitude		2000 m or less, indoors
Rated supply voltage		100 to 240 VAC
Permitted supply voltage range		90 to 264 VAC
Rated supply frequency		50/60 Hz
Permitted supply frequency range		45 to 66 Hz
Test fixture input voltage		5 V \pm 5%
Test fixture power fuse		1.1 A time lag, UL/CSA compliant
Maximum power consumption		Approximately 7 VA
Withstand voltage (AC adapter, between input terminal and output terminal)		3.0 kVAC for one minute
Insulation resistance (AC adapter, between input terminal and output terminal)		500 VDC, 100 M Ω or more
External dimensions		Approximately 317 (W) x 31 (H) x 75 (D) mm, excluding projections
Weight		Approximately 430 g, excluding AC adapter

Standard Accessories

AC adapter (A1626UP)	1
Power cord	1
Waveform Measurement Connector (B8080YH)	6
PBD2000 probe pin, B8080JP (variable type)	6
PBA2500 probe pin, B8080JP (variable type)	4
B8080JQ (straight type)	4
Carrying case (B8080JL)	1
User's manuals (this manual)	1
• Only with the /F30 option	
Software (CD-ROM)	1
Software user's manual (IM701985-61E)	1

The procedures for device, host, and hub are included in PDF format on the software CD-ROM.