

---

**User's  
Manual**

**4-CH, 100 kS/s D/A Module  
WE7281/WE7282**

IM 707281-01E  
2nd Edition

---

---

Thank you for purchasing the 4-CH, 100 kS/s D/A Module WE7281/WE7282 for the PC-based measurement instrument, WE7000.

This User's Manual contains useful information about the function, connection to the measuring station, operations of the software on the PC, and troubleshooting of the WE7281/WE7282. This manual assumes that you will be using the WE7000 Control Software that is included with the measuring station.

For general information about the WE7000 (primarily the operations of the measuring station, the optical interface module, the optical interface card, and the WE7000 Control Software) see the following manual that is included with the measuring station.

Manual Title	Manual No.
WE7000 User's Manual	IM707001-01E

To ensure correct use, please read this manual thoroughly before operation. Keep this manual in a safe place for quick reference in the event a question arises.

## Notes

- **The contents of this manual describe WE7000 Control Software Ver. 4.0.2.0 and module software Ver. 3.09. If you are using another version of the software, the operating procedures or the figures given in this manual may differ from the actual software.**
- The figures of operation panels that are used in this manual correspond to WE7281. If you are using WE7282, WE7282 will be displayed.
- The contents of this manual are subject to change without prior notice as a result of continuing improvements to the instrument's performance and functions.
- Every effort has been made in the preparation of this manual to ensure the accuracy of its contents. However, should you have any questions or find any errors, please contact your nearest YOKOGAWA dealer.
- Copying or reproducing any or all of the contents of this manual without YOKOGAWA's permission is strictly prohibited.

## Trademarks

- Microsoft, Windows, and Windows NT are either registered trademarks or trademarks of Microsoft Corporation in the United States and/or other countries.
- Adobe and Acrobat are trademarks of Adobe Systems Incorporated.
- Other product names are trademarks or registered trademarks of their respective holders.

## Revisions

1st Edition: September 1999

2nd Edition: August 2000

# Checking the Contents of the Package

Unpack the box and check the contents before operating the instrument. If the contents are not correct or missing or if there is physical damage, contact the dealer from which you purchased them.

## Measurement Module

Check that the model name given on the name plate matches those on the order.

### MODEL

Model	Description
707281	WE7281 4-CH, 100 kS/s D/A Module
707282	WE7282 4-CH, 100 kS/s D/A Module (BNC output terminals)

### NO.

When contacting the dealer from which you purchased the instrument, please quote the instrument No. The following is an example of WE7281. The name plate is also at the same position for WE7282.

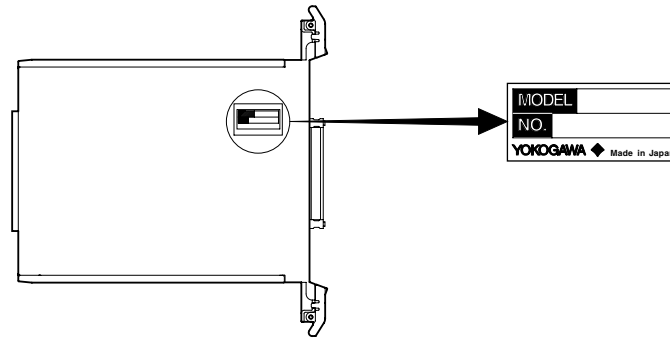

## Standard Accessories

The following standard accessories are supplied with the instrument. Make sure that all items are present and undamaged.

User's Manual (1)  
IM707281-01E

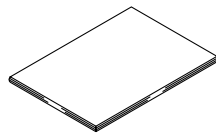

Terminal block (Model: A1460JT) (1)  
(Included only with WE7281, attached to the module)

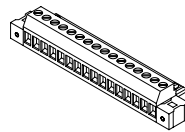

## Optional Accessories (Sold Separately)

Name	Model	Description
Terminal block	A1460JT	Clamp type terminal, sold in units of 1 piece

\* There are no optional accessories for WE7282.

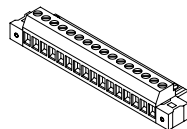

# How to Use This Manual

## Structure of the Manual

This User's Manual consists of the following five chapters and an index.

Chapter	Title	Description
1	Explanation of Functions	Explains the system configuration and functions.
2	Hardware Preparation	Explains how to install the module into the measuring station and how to connect the input.
3	Software Operation	Explains how to operate the software on the PC.
4	Troubleshooting and Maintenance	Explains the procedures for troubleshooting and self testing.
5	Specifications	Explains the specifications of the module.
Index		Index of contents.

## Conventions Used in This Manual

### Unit

k ..... Denotes 1000. Example: 100 kHz

K ..... Denotes 1024. Example: 720 KB

### Displayed characters

Alphanumeric characters enclosed with [ ] usually refer to characters or settings that are displayed on the screen.

### Symbols

The following symbol marks are used to attract the operator's attention.



Affixed to the instrument. Indicates danger to personnel or to the instrument. The operator must refer to the User's Manual. The symbol is used in the User's Manual to indicate the reference.

### Warning

Describes precautions that should be observed to prevent injury or death to the user.

### Caution

Describes precautions that should be observed to prevent minor or moderate injury, or damage to the instrument.

### Note

Provides information that is important for operating the instrument properly.



# Contents

Checking the Contents of the Package .....	2
How to Use This Manual .....	3
<b>Chapter 1 Explanation of Functions</b>	
1.1 Principles of Waveform Generation .....	1-1
1.2 System Configuration and Block Diagram .....	1-2
1.3 Waveforms That Can Be Generated .....	1-3
1.4 Waveform Generation in the DC Mode .....	1-4
1.5 Waveform Generation in the AG Mode .....	1-5
1.6 Waveform Generation in the FG Mode .....	1-8
1.7 Other Functions .....	1-14
1.8 Names and Functions of Sections .....	1-15
<b>Chapter 2 Hardware Preparation</b>	
△ 2.1 Installing the Module into the Measuring Station .....	2-1
△ 2.2 Connecting the Output Signal Wire .....	2-3
<b>Chapter 3 Software Operation</b>	
3.1 Selecting the Waveform Generation Mode .....	3-1
3.2 Setting the Output Conditions in the DC Mode .....	3-2
3.3 Setting the Output Condition in the AG Mode .....	3-4
3.4 Setting the Output Condition in the FG Mode .....	3-9
3.5 Turning ON/OFF the Output .....	3-16
<b>Chapter 4 Troubleshooting and Maintenance</b>	
4.1 Troubleshooting .....	4-1
4.2 Self Test .....	4-2
4.3 Maintenance .....	4-3
<b>Chapter 5 Specifications</b>	
5.1 Performance Specifications .....	5-1
5.2 Default Values (Factory Default Settings) .....	5-4
5.3 General Specifications .....	5-5
5.4 Dimensional Drawings .....	5-7
<b>Index</b> .....	Index-1

# 1.1 Principles of Waveform Generation

The 4-CH, 100 kS/s D/A Module WE7281/WE7282 has DC, AG, and FG waveform generation modes. Of the three modes, the operation principles of AG and FG modes are described here.

## AG mode

In the AG mode, waveform data previously written to the waveform memory are read according to the specified sampling interval and output sequentially (digital synthesis). As shown in the figure below, the address counter operates based on the clock, which has a frequency that is the inverse of the sampling interval, and provides addresses to the waveform memory. Data obtained from the waveform memory of the specified address are converted to an analog signal by the D/A converter and high frequency components are removed by the LPF. The data processor inside the module carries out the address counter operation, the reading of waveform data from the waveform memory, and the configuration of the waveform output D/A.

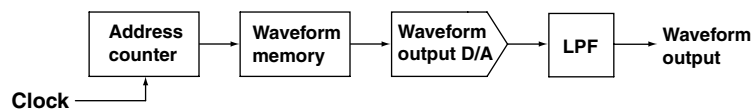

## FG mode

In the FG mode, waveform is generated using DDS (Direct Digital Synthesis). As shown in the figure below, DDS is composed of a reference clock signal generator, a phase computing unit, a waveform memory containing one cycle of waveform data, a D/A converter, a LPF, and other components. Because the waveform memory only stores the data for one-cycle of the waveform, the address values correspond to the phase angles of the waveform.

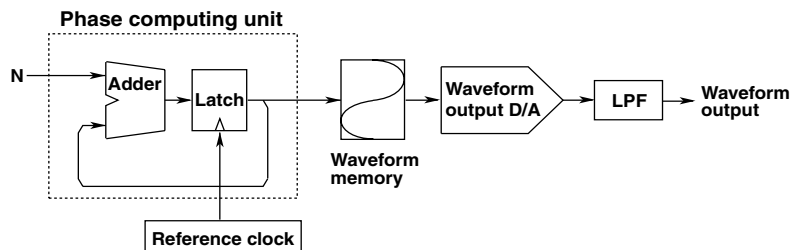

If  $N$  is one input to the adder and the other input is 0, the adder outputs  $N$ . The latching circuit outputs  $N$  in sync with the standard clock. This value,  $N$ , will be the first address of the waveform memory. Next, the  $N$  that is output from the latching circuit is input to the adder which then outputs  $2N$ . The latching circuit outputs  $2N$  in sync with the next clock cycle. The result is continuously added and the phase computing unit outputs  $3N$ ,  $4N$ , and so on, for every clock cycle. These values,  $N$ ,  $2N$ ,  $3N$ , ... become the waveform memory addresses. The data at the specified address is converted to an analog signal through the D/A converter, and high frequency components are removed with the LPF. In this DDS method, If the value  $N$  is applied to the input of the phase computing unit such that the specified address is three greater than the previous address, the output frequency will be increased by a factor of three if the clock frequency stays the same. Thus, the output frequency of the waveform can be adjusted by changing the value of  $N$ . Also, by changing the data in the waveform memory, the circuit can output other waveforms such as triangular and pulse waveforms that are provided by the module as well as arbitrary waveforms that are loaded externally.

The data processor inside the module carries out the phase computing unit operation, the reading of waveform data from the waveform memory, and the configuration of the waveform output D/A.

## 1.2 System Configuration and Block Diagram

### System Configuration

The following shows an example in which a 4-CH D/A Module WE7281 is installed in the measuring station and the measuring station is connected to the PC through the optical fiber cable.

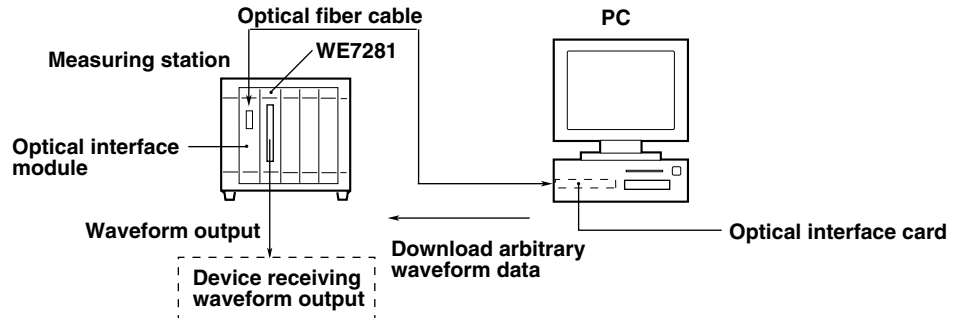

### Block Diagram

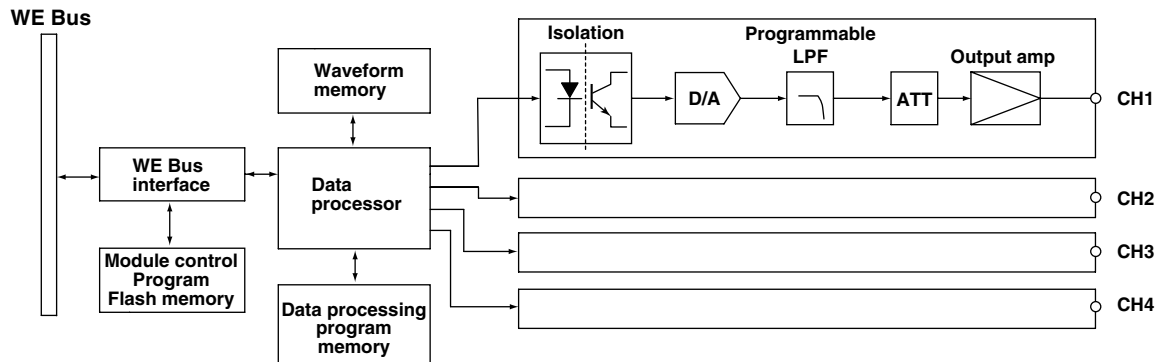

The data processor on the module creates and processes the waveform data according to instructions from the PC that are received via the WE bus of the measuring station. The waveform data passes through the isolator. Then, they are converted to analog values using the D/A converters of each channel. The programmable LPF, that is optimized according to the waveform, removes the high frequency components. Then, the ATT adjusts the level of the signal according to the output range, and then finally the output amplifier outputs the analog signal. The isolators of each channel are independent, and each channel is isolated from one another.

## 1.3 Waveforms That Can Be Generated

This module has the following three waveform generation modes. One mode is selected and the waveform is generated.

DC : DC signal

AG : Arbitrary waveform

FG : Sine wave, pulse wave, ramp wave, triangular wave, arbitrary wave, and DC signal.

The functional differences between each waveform generation mode are as follows:

	DC	AG	FG
Generated waveform	Constant voltage output	Loaded arbitrary waveform	Sine, pulse, ramp, triangular, loaded arbitrary waveform, etc.
Arbitrary waveform downloading	No	Yes	Yes
Output frequency	—	—	1 mHz to 10 kHz*
Operation mode	Cont Trigger Gate	One Shot Cont Trigger Repeat	Cont Trigger Gate
Sweep	No	No	Frequency, amplitude, duty
Offset voltage	No	No	Yes
Phase	No	No	Yes

\*1 mHz to 20 kHz during sine wave generation.

The differences between the creation and generation of arbitrary waveforms in the AG mode and in the FG mode are as follows:

### AG mode

- Used when outputting pattern waveforms.
- The maximum allowable data length is 4 Mwords/CH (when using 1 CH)
- Data saved by digital oscilloscope and digitizer modules can be used directly.
- Each channel of waveform memory can be divided into multiple blocks and waveform data can be loaded to the individual blocks.

### FG mode

- Used when outputting a constant waveform in units of one cycle.
- The data length is fixed to 64 Kwords.
- The output frequency can be set up to 10 kHz (20 kHz for sine waves).
- The frequency and amplitude can be specified.
- Frequency and amplitude sweeps are possible.
- The offset and phase difference between channels can be specified.

## 1.4 Waveform Generation in the DC Mode

### Setting the Output Conditions

You can turn ON/OFF the output and set the output voltage range for each channel.

#### Setting the output voltage range

You can select the range from the following list of choices.

Setting	Possible Output Range	Resolution
1 V	-1 to 1 V	0.1 mV
2 V	-2 to 2 V	1 mV
5 V	-5 to 5 V	1 mV
10 V	-10 to 10 V	1 mV

#### Setting the output voltage

You can set an output voltage that falls within the allowed range that corresponds to the specified output voltage range setting.

#### Trigger signal output

A trigger signal is output to the WE bus of the measuring station when the output value of the specified channel is changed.

### Selecting the Output Mode

The following three modes are available.

#### Continuous output

Continuously outputs the DC voltage signal at the specified level.

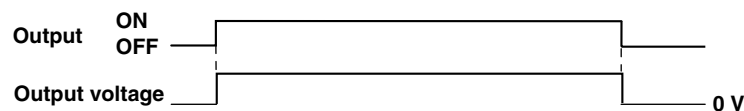

#### Trigger output

Outputs the DC voltage signal at the specified level when a trigger occurs.

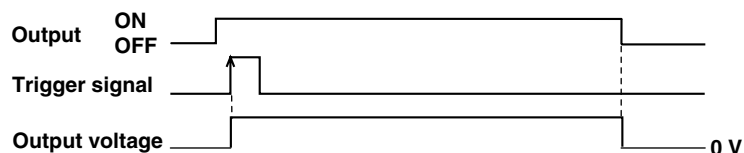

#### Gate output

Outputs the DC voltage signal at the specified level while the gate signal is enabled.

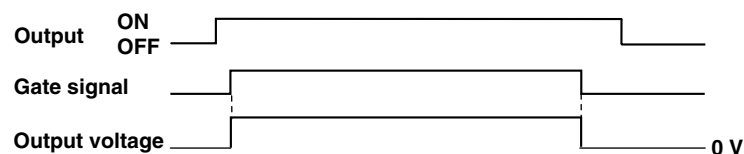

#### Note

- When the output mode is set to [Trigger], the trigger can be activated by inputting the bus trigger signal\* or by clicking the [Manual Trigger] button on the operation panel.
- When the output mode is set to [Gate], the gate can be opened or closed by inputting the bus trigger signal\* as a gate signal or by pressing down on the [Manual Trigger] button on the operation panel for the desired amount of time during which the signal is enabled.
- \* A trigger signal that is provided via the WE bus of the measuring station. For details, see the WE7000 User's Manual (IM 707001-01E).

## 1.5 Waveform Generation in the AG Mode

### Setting the Output Conditions

You can turn ON/OFF the output and set the output voltage range for each channel.

#### Setting the output voltage range

You can select the range from the following list of choices.

Setting	Possible Output Range
1 V	-1 to 1 V
2 V	-2 to 2 V
5 V	-5 to 5 V
10 V	-10 to 10 V

#### Selecting the time base

You can select the time base from internal or external clock. The sampling interval can be specified only when internal clock is selected.

#### Setting the sampling interval

Set the interval that is used to read the waveform data from the waveform memory. When auto load is used to load waveform data, the sampling interval setting is also loaded. However, the sampling interval can be changed after the waveform data are loaded. The range is 10  $\mu$ s to 10 s (10  $\mu$ s resolution). This setting is valid only when the time base setting is [Internal].

#### Setting memory partitions

The waveform data memory can be divided into multiple blocks. The data that are registered in each memory block can be output sequentially every time the trigger occurs. You can select the number of partitions from 1, 2, 4, 8, 16, 32, 64, 128, and 256. When auto load is used to load waveform data, the number of partitions is set to the number of blocks of the waveform data being loaded.

#### Setting the data length

You can specify the data length of the waveform to be generated. The range is from 10 to the maximum usable data length. When auto load is used to load waveform data, the data length is set to that of the waveform data being loaded.

#### Setting the block to be output

You can specify the starting and ending blocks that are to be output the waveform from the divided waveform memory. The operation varies depending on the output mode (see next section) as follows.

- One Shot/Cont/Repeat : Outputs the waveform of the block specified by the [Start Block No.].
- Trigger : Sequentially outputs the waveform from blocks [Start Block No.] through [End Block No.] every time a trigger occurs.

#### Setting the output timing of the trigger signal

When the data at the specified position of the output waveform (the specified point from the beginning of the waveform data) are output, a synchronized trigger signal is output to the WE bus of the measuring station.

### Selecting the Output Mode

#### One shot

Outputs the one-shot waveform of the specified block.

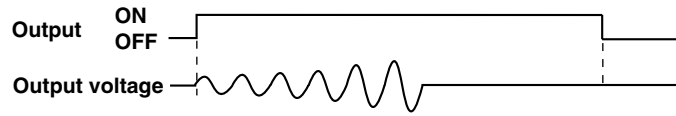

#### Continuous oscillation

Continuously outputs the waveform of the specified block.

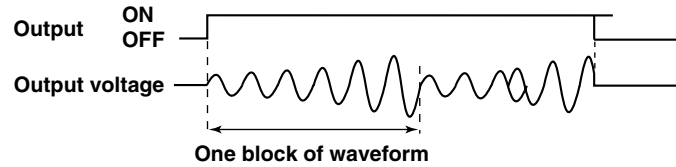

#### Trigger oscillation

The waveforms set in the Start block to the End block are sequentially output every time a trigger occurs. When the End block is reached, the waveform pointer returns to the Start block.

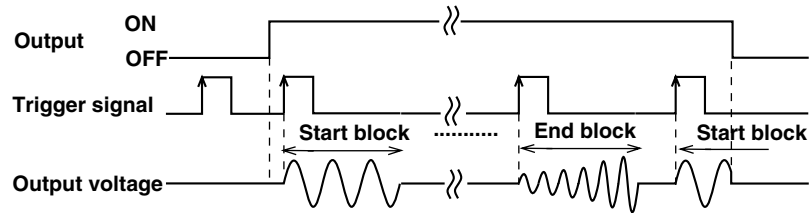

#### Repeat

Continuously outputs the waveform in the specified block when a trigger occurs.

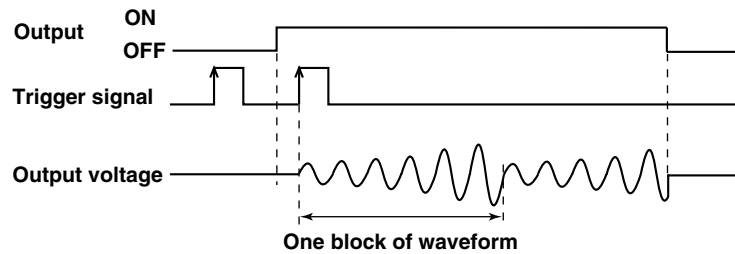

#### Note

- The trigger can be activated by inputting the bus trigger signal\* or by clicking the [ManualTrigger] button on the operation panel.
- \* A trigger signal that is provided via the WE bus of the measuring station. For details, see the WE7000 User's Manual (IM 707001-01E).
- A trigger that occurs while a waveform is being generated is ignored.
- If the output voltage range of a channel is changed while the waveform is being generated, waveform generation of all channels is temporarily suspended.

## Creating and Loading Arbitrary Waveform Data

Data that can be loaded as arbitrary waveform data must be of YOKOGAWA's proprietary file format (extension: wvf) or be ASCII data in csv format.

### Creating arbitrary waveform data

#### Creating a wvf file.

The file can be created in one of the following ways.

- Make measurements on the 4-CH, 100 kS/s Isolated Digitizer Module WE7271 or other appropriate modules, and save the waveform data in wvf format.
- Use the Waveform Editor (707751) and save the arbitrary waveform data in wvf format.

#### Creating ASCII data in csv format

Create a new ASCII data file in csv format according to the following guideline (extract only the waveform data) from an ASCII data file in csv format that was saved using another module or from a file that was created by using a spreadsheet application.

Column data : Handle as channel data.

Row data : Handle as time axis data

For details, see page 1-13.

### Loading method of arbitrary waveform data

Select and load the wvf or csv file containing the arbitrary waveform data that were created according to the steps above. When loading a wvf file, a corresponding header file (file extension: [.hdr]) is also needed. Auto and manual loading methods are available.

#### Auto load

Loads the data of all channels and blocks in the file at once. For wvf files, the following settings are also loaded: the number of channels, the output voltage range of each channel, the number of block partitions, and the sampling interval. For csv files, the number of channels used is automatically loaded, but the number of block partitions is set to 1.

#### Manual load

Loads the data of the specified slot, channel, and block number. Only one block of one channel can be loaded at once.

When using manual load, the slot/channel, block number, number of channels used, and number of memory partitions of the data being loaded are specified.

#### Selecting the slot/channel

Select the slot/channel of the data being loaded.

#### Selecting the block number

Select to which block of the waveform data memory to load. This number is [1] when the memory is not partitioned.

#### Selecting the number of channels used

Select the number of channels to use from 1, 2, or 4 channels.

### Restrictions when loading arbitrary waveform data

The length of data that can be loaded varies depending on the number of channels used and the number of memory partitions as follows. Data that exceed the maximum allowable data length are discarded when loading the data.

Number of Channels used	Maximum Allowable Data Length
1	4 Mwords/number of memory partitions
2	2 Mwords/number of memory partitions
4	1 Mword/number of memory partitions

Data cannot be loaded using the auto load function if (the number of channels x the number of blocks) is greater than 256 and the data length of each block is less than 150.

## 1.6 Waveform Generation in the FG Mode

### Selecting the Output Waveform (Function)

Select the output waveform from the following list of choices. You can also select waveform inversion.

#### Sine wave

Generates a sine wave with a frequency between 1 mHz and 20 kHz.



#### Pulse wave

The selectable oscillation frequencies range from 1 mHz to 10 kHz. A pulse waveform of 0 to 100% duty cycle can be generated.



#### Ramp wave

The selectable oscillation frequencies range from 1 mHz to 10 kHz.



#### Triangular wave

Generates a triangular wave with 50% symmetry. The selectable oscillation frequencies range from 1 mHz to 10 kHz.



#### Arbitrary waveform

An arbitrary waveform can be generated by loading the arbitrary waveform data (data length is fixed to 64 Kwords). The selectable oscillation frequencies range from 1 mHz to 10 kHz.



#### DC

The selectable output voltage is the same as the possible output range corresponding to the output voltage range setting.

## Selecting the Output Mode (Continuous Oscillation/Trigger Oscillation/Gate Oscillation)

The following three output modes are available.

### Continuous oscillation

Continuously generates the waveform.

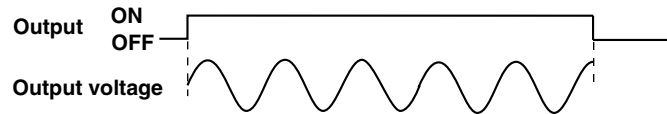

### Trigger oscillation

Continuously generates the waveform when a trigger occurs.

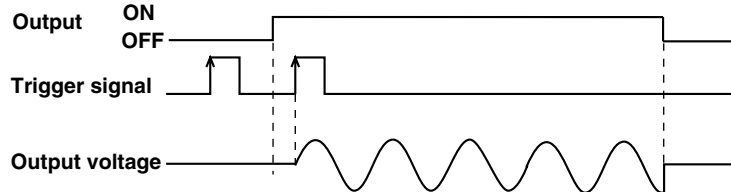

### Gate oscillation

Generates the waveform while the gate signal is enabled. The waveform is generated in units of one cycle. Therefore, the waveform that is being generated at the end of the enable period is output until the end of the cycle.

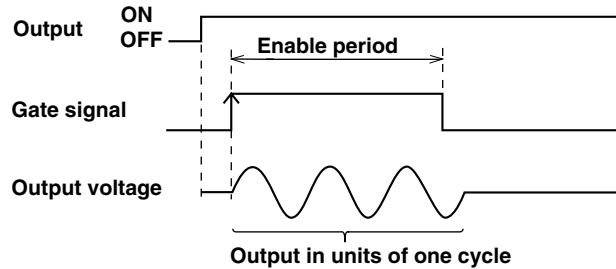

### Note

- When the output mode is set to [Trigger], the trigger can be activated by inputting the bus trigger signal\* or by clicking the [Manual Trigger] button on the operation panel.
- When the output mode is set to [Gate], the gate can be opened or closed by inputting the bus trigger signal\* as a gate signal or by pressing down on the [Manual Trigger] button on the operation panel for the desired amount of time during which the signal is to be enabled.  
\*A trigger signal that is provided via the WE bus of the measuring station. For details, see the WE7000 User's Manual (IM 707001-01E).
- A trigger that occurs while a waveform is being generated is ignored.
- If the output voltage range of a channel or the frequency, amplitude, or duty during a sweep operation is changed while the waveform is being generated, waveform generation on all channels is temporarily suspended.
- When the sweep operation is turned ON, the output mode is set to [Cont].

## Setting the Output Conditions (Output Frequency, Output Voltage, and Phase)

### Output frequency

When the output waveform is a sine wave, the frequency can be set in the range from 1 mHz to 20 kHz. For all other waveforms, the frequency can be set in the range from 1 mHz to 10 kHz. However, for pulse, ramp, triangular, and arbitrary waveforms, the frequency range for which high quality waveforms are obtained is 1 mHz to 1 kHz.

### Output voltage range

Select the range from the following list of choices.

Setting	Possible Output Range
1 V	-1 to 1 V
2 V	-2 to 2 V
5 V	-5 to 5 V
10 V	-10 to 10 V

### Output voltage

Amplitude and offset voltage settings are available for the output voltage. For the ranges, see section 5.1, "Performance Specifications."

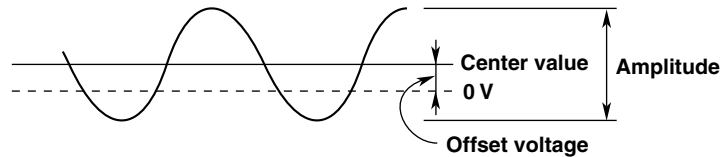

### Phase

You can set the initial phase of the oscillation for each channel. However, if the phase setting is changed after waveform generation is started, the actual phase differences between the waveforms of each channel are not necessarily the phase differences that were specified.

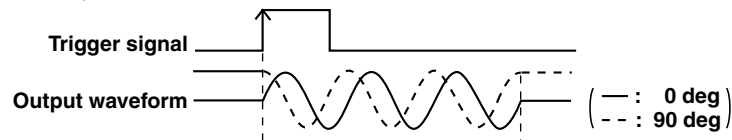

### Setting the output timing of the trigger signal

When the data at the specified phase of the output waveform (one cycle is taken to be 360 deg) are output, a synchronized trigger signal is output to the WE bus of the measuring station.

### Note

- When the output mode is set to [Cont], the waveform generation starts from the specified phase when the output is turned ON.
- When the output mode is set to [Trigger] or [Gate], the waveform generation starts from the specified phase when a trigger occurs or the gate signal is enabled.

## Setting Sweeps

### Selecting the parameter to sweep

Select which parameter to sweep from the following list of choices.

Off : Do not sweep

Freq : Sweep the frequency

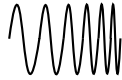

Ampl : Sweep the amplitude



Duty : Sweep the duty cycle (selectable only for pulse waveform)

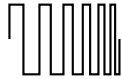

Freq & Ampl : Sweep the frequency and amplitude



### Selecting the sweep pattern

Select how to sweep the parameter from the following list of choices.

Linear: Sweep linearly

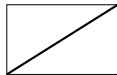

Log: Sweep logarithmically



Arbitrary: Sweep using an arbitrary pattern



### Loading the sweep pattern

When the sweep pattern is set to [Arbitrary], an arbitrary pattern is loaded.

You can load the following files containing data of length 64 Kwords.

- wvf file (a corresponding header file with file extension [.hdr] is also needed, see page 1-13)
- ASCII data in csv format (see page 1-13)

### Note

- If the data length of the file being loaded is greater than 64 Kwords, the first 64 Kwords of data are loaded. If it is shorter, data after the last data point are filled with the value of the last data point.
- When an arbitrary pattern is loaded, the minimum and maximum values of the data correspond to the values in the [... Start] and [... End] boxes of the parameter to be swept, respectively.

**Selecting the sweep mode**

Select the sweep mode from the following choices.

Off : Do not sweep

Repeat : Sweep continuously



Single : Sweep once when a trigger occurs

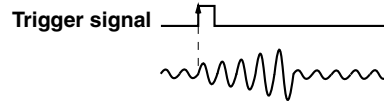

Single&Hold : Perform a single sweep when a trigger occurs, then hold the last value and output a continuous oscillation waveform

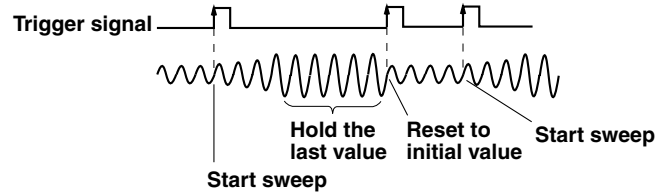

**Setting the sweep time**

Set the time duration for one sweep operation. The selectable range is 1 to 1000 s.

**Note**

- Sweep control will be used for trigger input signals if the sweep mode not set to OFF.
  - Trigger outputs during a frequency sweep may differ from the appointed phase.
-

## Arbitrary Waveform Output

Data that can be loaded as arbitrary waveform data are as follows.

- A file with a [.s16] file extension (Created using the Waveform Editor (707751) that is sold separately)
- A wvf file (a corresponding header file is also needed (file extension: [.hdr])
- ASCII data in csv format

### Creating arbitrary waveform data

#### • A file with a [.s16] extension

Create the data according to the following procedure.

##### Number of bits

16 bit (Little Endian, signed)

##### Value assignment

-32767 : Negative side of Vp-p

0 : 0 V

32767 : Positive side of Vp-p

##### Data length

64 Kwords (If the data length is greater than 64 Kwords, only the first 64 Kwords are taken. If it is shorter, data after the last data point are filled with the value of the last data point.)

##### Extension

\*.s16

#### • A wvf file (a corresponding header file is also needed that has the file extension: [.hdr])

Save the waveform data on another module to [\*.wvf] format, or create the data using the Waveform Editor (707751).

#### • ASCII data in csv format

Create a new ASCII data file in csv format according to the following guideline (extract only the waveform data) from an ASCII data file in csv format that was saved using another module or a file that was created by using a spread sheet application.

- Column data : Handle as channel data.
- Row data : Handle as time axis data

When creating data in csv format, make sure to fill the data from the beginning. If there are too many points, the points beyond the 65537th point are discarded. If there are not enough points, the points beyond the last data point are filled with the value of the last data point.

#### Example of a csv format file

	CH1	CH2	CH3	CH4	.....
Time axis data ↓ 1	0.1	-2.1	1.5	-5	.
2	0.3	-1.2	1.3	-3	.
3	0.5	0.1	1.8	1	.
.	.	.	.	.	.
.	.	.	.	.	.
.	.	.	.	.	.

### Loading arbitrary waveform data

Select and load the file containing the arbitrary waveform data that were created according to the steps above.

### Setting the arbitrary waveform output

Set the output frequency, output voltage (amplitude, offset voltage) and phase.

---

## 1.7 Other Functions

### Input/Output of Bus Trigger Signals

You can output a signal that is synchronized to the waveform output (trigger output signal) to the two trigger signal buses (BUSTRG1/BUSTRG2) in the measuring station. The trigger output signal is set to "True" for approximately 160 ns (typical value\*). There is a time difference of approximately 12.5  $\mu$ s (typical value\*) between the trigger output signal and the bus trigger signal.

In addition, the bus trigger signal can be used as the trigger/gate signal during trigger oscillation and gate oscillation operations. There is approximately 12.5  $\mu$ s (typical value\*) of delay time from the time the bus trigger signal becomes "True" to the time the trigger oscillation starts. And, there is a delay of approximately 12.5  $\mu$ s from the time the bus trigger signal becomes "True" to the time the gate oscillation starts.

\* Typical values represent typical or average values. They are not strictly guaranteed.

# 1.8 Names and Functions of Sections

## Front Panel

WE7281

**START indicator**  
Lights when the waveform is being output.

**Terminal block**  
Provides 4 channels of output terminals.

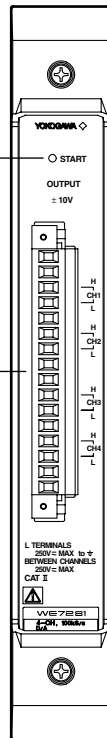

WE7282

**Start indicator**  
Lights when the waveform is being output.

**Output terminal**  
Provides 4 channels of BNC output terminals.

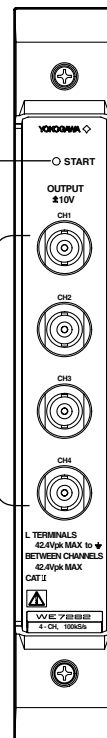

## 2.1 Installing the Module into the Measuring Station

### Preparing to Install the Module

Upon purchasing the measuring station, each slot is covered with a cover plate as shown in the figure below. Verify that the power supply is not connected to the measuring station, then loosen the module attachment screws (2 locations) and remove the cover plate from the slot where the module is going to be installed. Please note that the slot on the left end is dedicated to the communication interface module and this module cannot be installed there.

\* The following figure shows an example of the measuring station WE400.

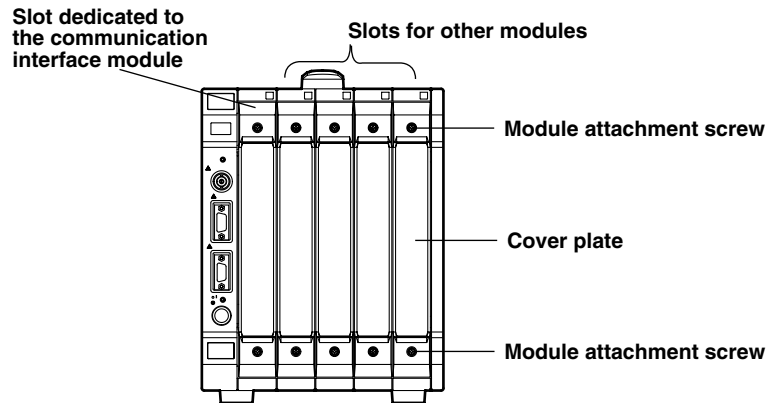

### Installing the 4-CH, 100 kS/s D/A Module



#### WARNING

- Make sure to fasten the top and bottom attachment screws. If you connect the input signal cable without fastening the attachment screws, the protective grounding of the measuring station provided by the power cord is compromised and may cause electric shock.



#### CAUTION

- To avoid damaging the instrument when installing modules, make sure to turn OFF the standby power switch of the measuring station.
- Be careful not to get your fingers caught in the ejection lever while inserting the module. In addition, do not put your hand inside the slot, because there are protrusions along the module guide. You may injure your fingers from them.
- Do not remove the cover plates from unused slots. It can cause overheating and cause malfunction. Cover plates are also needed to minimize the influence caused by electromagnetic interference.

Insert the module along the guide rail of the slot from which you removed the cover plate. Insert the module until it clicks into the connector. Be careful not to get your fingers caught in the ejection lever while inserting the module. When the module is securely inserted, fasten the module attachment screws (tightening torque: 0.6 to 0.7 N-m). To remove the module, loosen the module attachment screws, and pull the ejection lever from the inside to the outside. This will force the module out of the slot.

## 2.1 Installing the Module into the Measuring Station

---

The following figure shows an example of WE7281. WE7282 can also be installed or removed in a similar fashion.

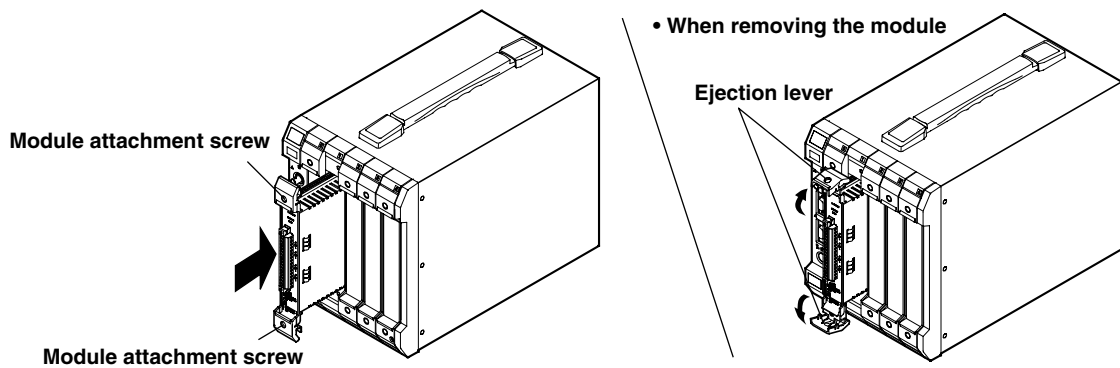

---

### **Note**

When synchronizing output signals from multiple 4-CH, 100 kS/s D/A modules, install the modules in adjacent slots.

---

## 2.2 Connecting the Output Signal Wire

For WE7281

The output signal wires are connected to the terminal block of the 4-CH, 100 kS/s D/A module.

### Pin arrangement of the terminal block

The output terminal is a clamp type terminal, and the pin arrangement is as follows.

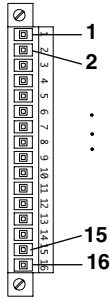

Pin Number	Signal	Pin Number	Signal
1	FG (Frame ground*)	11	CH3 L (CH3 negative)
2	N.C. (No connection)	12	N.C. (No connection)
3	CH1 H (CH1 positive)	13	CH4 H (CH4 positive)
4	CH1 L (CH1 negative)	14	CH4 L (CH4 negative)
5	N.C. (No connection)	15	N.C. (No connection)
6	CH2 H (CH2 positive)	16	FG (Frame ground*)
7	CH2 L (CH2 negative)		
8	N.C. (No connection)		
9	N.C. (No connection)		
10	CH3 H (CH3 positive)		

\* Ground potential

### Connecting the signal wires



### CAUTION

- Do not apply a voltage exceeding the following levels, as it may damage the module.  
 Maximum common mode voltage : 250 VACrms or  $\pm 250$  VDC between the ground and the L terminal  
 Maximum voltage between channels : 250 VACrms or  $\pm 250$  VDC between terminals of different channels
- Do not connect to the N.C. (no connection) terminals. Applying signal to them may damage the module.
- Do not apply external voltage across the output terminals of the same channel, as it may damage the module.



### WARNING

- Make sure that the conducting parts of the output signal wire are not showing from the opening (insertion point) of the terminal block. It can lead to electric shock.

The terminal block can be removed from the module by loosening the two attachment screws as shown in the following figure. When removing or attaching the terminal block, make sure to turn OFF the standby power switch on the measuring station.

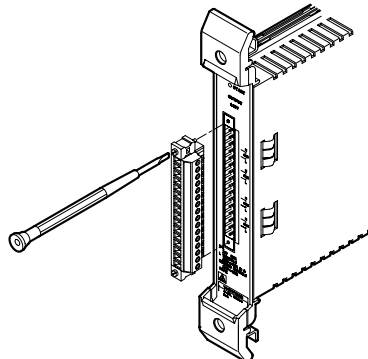

## 2.2 Connecting the Output Signal Wire

When connecting the output signal wire to the clamp type terminal, loosen the screw holding down the clamp, insert the output signal wire into the opening, and then tighten the screw.

Recommended length of the stripped portion of the output signal wire: 7 mm  
Thickness of the output signal wire (for twisted wire) : 0.5 to 1.5 mm<sup>2</sup>

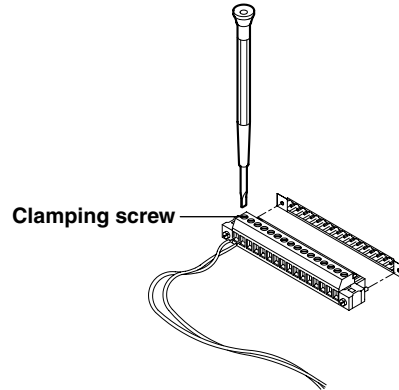

### For WE7282



Use a BNC cable for the output signal. The BNC cable is connected to the output terminal (isolated BNC) on the front panel of the module. There are four channels of output terminals.

### **CAUTION**

- Do not apply voltages that exceed the following values, as it may damage the module.  
Maximum common mode voltage:  $\pm 42.4 \text{ VDC} + \text{AC}_{\text{peak}}$  between the ground and the L terminal  
Maximum voltage between channels:  $\pm 42.4 \text{ VDC} + \text{AC}_{\text{peak}}$  between terminals of different channels

### **Note**

The maximum length of the cable that is connected to the output connectors of WE7281/WE7282 is 20 m. However, if the cable length exceeds 3 m, undesirable effects such as delay in the rise time of the output waveform or distortion may occur.

## 3.1 Selecting the Waveform Generation Mode

In this section, you will be using the operation panel that appears by double-clicking the module icon in the station list window as shown in the figure below

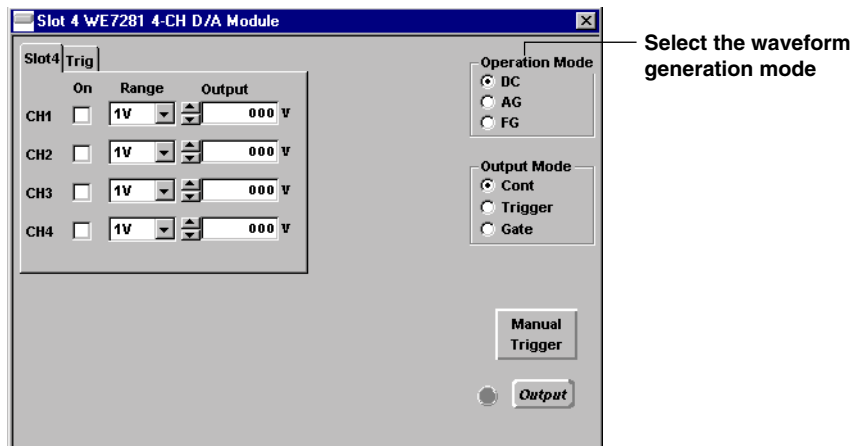

### Selecting the Waveform Generation Mode

Select the mode using the [Operation Mode] option button. The choices are shown below. [DC] is default.

#### DC: DC output

Outputs DC voltage.

#### AG: Arbitrary waveform output

Outputs an arbitrary waveform using waveform data that are loaded.

#### FG: Function generator output

Outputs the selected waveform. The selectable waveforms are sine, pulse, and other constant waveforms as well as arbitrary waveforms that are loaded.

## 3.2 Setting the Output Conditions in the DC Mode

In this section, you will be using the operation panel that appears by double-clicking the module icon in the station list window as shown in the figure below and the trigger operation panel that appears by clicking the Trig tab.

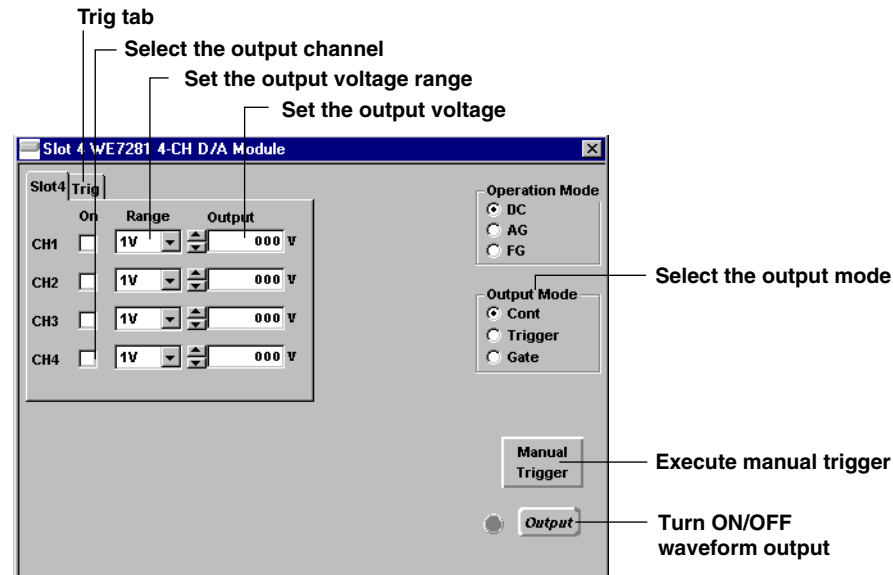

### Selecting the Output Channel

Check the [On] box of the channel you wish to output.

### Setting the Output Voltage Range

Select the output voltage range from [1 V], [2 V], [5 V], and [10 V] in the [Range] list box.

### Setting the Output Voltage

Set the output voltage in the [Output] entry box. The output voltage can be set in units of 0.0001 V in the 1 V range and 0.001 V for all other ranges.

### Setting the Output Mode

Select the output mode using the [Output Mode] option button. The choices are shown below. [Cont] is default.

#### Cont: Continuous output

Continuously outputs DC voltage from the time the [Output] button is clicked to turn the output ON until the next time it is clicked to turn the output OFF.

#### Trigger: Trigger output

After the [Output] button is clicked to turn ON the output, DC voltage is continuously output when a trigger occurs. If the output voltage is changed while the waveform is being output, the new DC voltage is output the next time the trigger occurs.

#### Gate: Gate output

After the [Output] button is clicked to turn ON the output, the output starts when the gate is enabled and stops when it is disabled. The output voltage can be changed while the gate is enabled.

#### Note

When the output is OFF, the waveform output terminal of the module outputs 0 V.

### Selecting the Trigger Signal Output Source Channel

The trigger operation panel shown below is used to set the trigger signal output source channel.

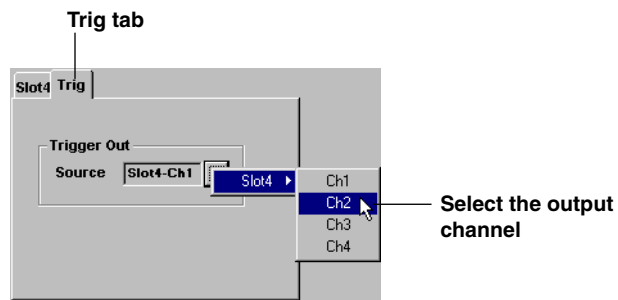

Click the [Source] button to select the source channel that will be used to output the trigger signal. When the output value of the source channel changes, the trigger signal is generated.

## 3.3 Setting the Output Condition in the AG Mode

In this section, you will be using the operation panel that appears by double-clicking the module icon in the station list window as shown in the figure below and the trigger and Misc operation panels that appear by clicking the Trig and Misc tabs, respectively.

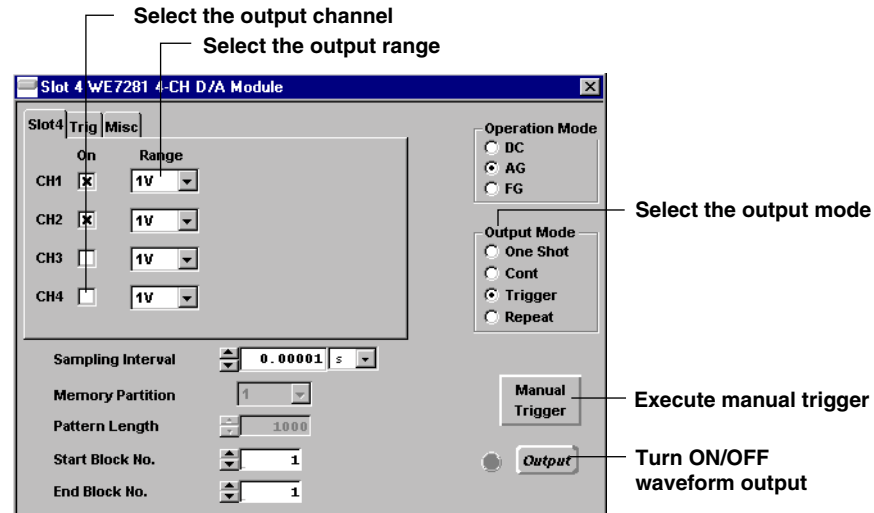

### Selecting the Output Channels and Range

Click the [On] box of the channel you wish to output. Select the range from [1 V], [2 V], [5 V], and [10 V] in the [Range] list box.

### Selecting the Output Mode

Select the output mode using the [Output Mode] buttons. The default is [One Shot].

#### One Shot: Single shot oscillation

Outputs the waveform once when the output is turned ON by clicking the [Output] button.

#### Cont: Continuous oscillation

Continuously outputs the waveform of the block specified by [Start Block No.], from the time the output is turned ON by clicking the [Output] button until the output is turned OFF by again clicking the [Output] button.

#### Trigger: Trigger oscillation

After the output is turned ON by clicking the [Output] button, the waveform set in blocks [Start Block No.] through [End Block No.] are sequentially output every time a trigger occurs. When block [End Block No.] is reached, the oscillation returns to the [Start Block No.].

#### Repeat: Repetitive oscillation

After the output is turned ON by clicking the [Output] button, the waveform set in block [Start Block No.] is repetitively output when a trigger occurs.

#### Note

When the output is OFF, the waveform output terminal of the module outputs 0 V.

### Setting the Output Timing of the Trigger Signal

The trigger operation panel shown below is used to set the output timing.

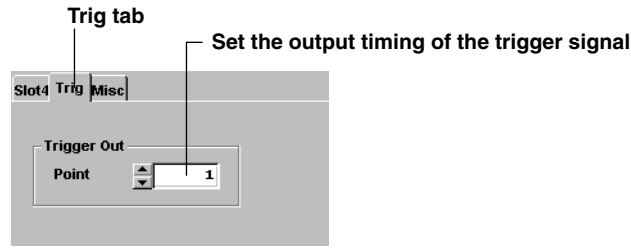

Specify at what position of the output waveform to output the trigger signal in the [Point] entry box. The range is from 1 to the data length. For details regarding the data length, see page 1-7.

### Setting the Memory Partition, Time Base, and Arbitrary Waveform Data Loading

The Misc operation panel shown below is used to set the following settings.

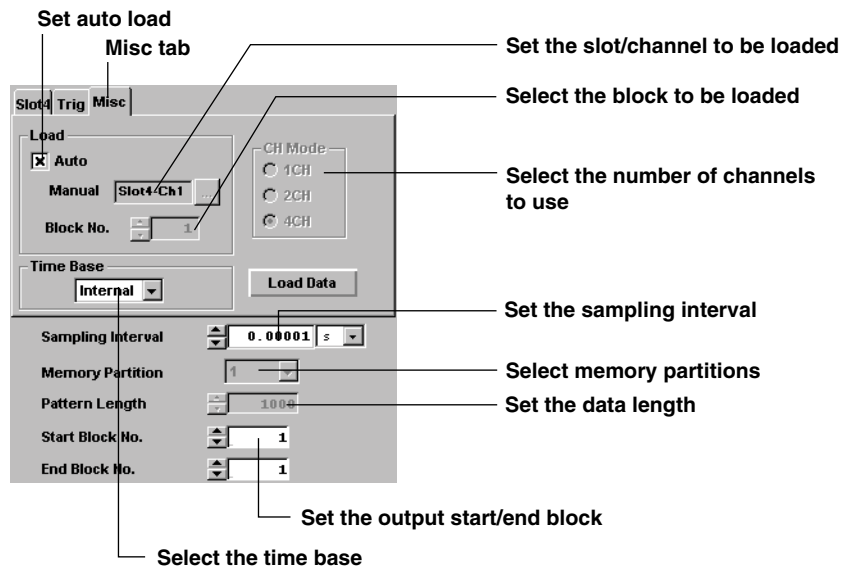

#### Selecting the time base

Select which of the following time bases to use during data output in the [Time Base] list box.

Internal : Sample the waveform data using the sampling interval based on the module's internal clock

BUSCLK: Sample the waveform data by synchronizing to the time base signal of the measuring station (CMNCLK)\*

\* For setting procedures, see section 4.6, "Setting the Trigger Source/Time Base Source/Arming" in the WE7000 User's Manual (IM707001-01E).

#### Setting the sampling interval

Set the interval when sampling the waveform data using the internal clock. When auto load is used to load waveform data in wvf format, the sampling interval of the waveform data is also loaded. However, this value can be changed by entering a value in the [Sampling Interval] entry box. A value can be entered in the [Sampling Interval] entry box only when the time base is set to internal clock. The range is 10 μs to 10 s. The resolution is 10 μs. The default is 10 μs.

#### Selecting the number of channels used

Select the maximum number of channels used of the waveform to be loaded with the [CH Mode] option button. The choices are shown below. When auto load is used to load waveform data, this number is automatically set to the number of channels used of the waveform data being loaded. The length of data that can be loaded varies depending on the number of channels used and the number of memory partitions as follows.

1CH: Load one channel of data. Load up to 4 Mwords/number of memory partitions.

2CH: Load two channels of data. Load up to 2 Mwords/number of memory partitions.

4CH: Load four channels of data. Load up to 1 Mword/number of memory partitions.

#### Selecting the memory partition

Select the number of waveform memory partitions (number of blocks) from 1, 2, 4, 8, 16, 32, 64, 128, and 256 in the [Memory Partition] list box. When auto load is used to load waveform data, the number of memory partitions is automatically set according to the number of blocks of the waveform data. (For example, if the number of blocks is 10, the number of memory partitions is set to 16.)

#### Setting the data length

Set the data length of the output waveform in the [Pattern Length] entry box. The range is 10 to (the maximum allowable data length). When auto load is used to load waveform data, the data length is automatically set to the data length of each block of the waveform data being loaded.

#### Note

---

Data in the memory are cleared when the number of channels or memory partitions is changed.

---

#### Setting the Start/End block

Set the start and end numbers of the block in the [Start Block No.] and [End Block No.] list boxes, respectively. The operation varies depending on the output mode as follows.

One Shot/Cont/Repeat : Outputs only the waveform of the [Start Block No.].

Trigger : Sequentially outputs the data from blocks [Start Block No.] through [End Block No.] every time a trigger occurs. When block [End Block No.] is reached, the pointer returns to block [Start Block No.].

#### Setting the arbitrary waveform data loading

##### Auto load

Load the waveform data according to the following procedure.

1. Check the [Auto] box and click the [Load Data] button. The following dialog box appears.

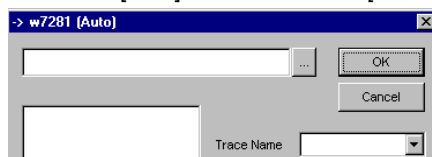

2. Clicking the button to the left of the [OK] button opens the [Open] dialog box. Select a file with extension [.wvf] or [.csv] and click the [Open] button.

3. The following dialog box appears. Clicking the [OK] button causes the number of channels and blocks of the waveform data to be automatically determined, and the waveform data to be loaded.

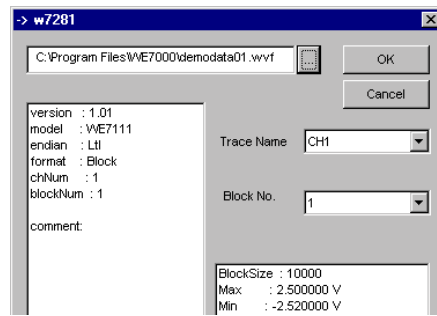

#### Note

- When loading waveform data, the data length of all channels in the same block must be of the same length for the data to load properly. When loading a file in wvf format containing computed waveforms, the data length may be different. Check the data length of each channel by checking Block size in the dialog box.
- For waveform files in csv format, only one block can be loaded.

#### Manual Load

Load the waveform data according to the following procedure.

1. Set the number of channels (CH Mode) and the number of memory partitions (Memory Partition) of the waveform data to be loaded.
2. In the menu that appears by clicking the [Manual] button, select the slot/channel number to which the waveform data are to be loaded.

When the 4-CH, 100 kS/s D/A modules are not linked, only the slot number of the selected module is displayed. When the modules are linked, the slot numbers of all slots that have modules installed are displayed.



3. Select the block number to which the data are to be loaded in the [Block No.] list box.
4. Clicking the [Load Data] button displays the following dialog box.

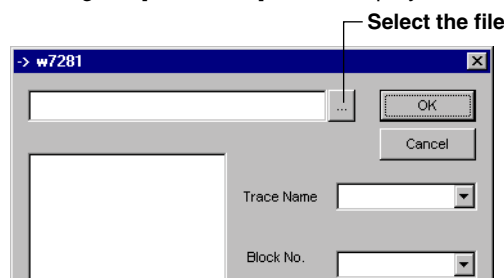

### 3.3 Setting the Output Condition in the AG Mode

5. Clicking the button to the left of the [OK] button opens the [Open] dialog box. Select a file with extension [\*.wvf] or [\*.csv] and click the [Open] button.

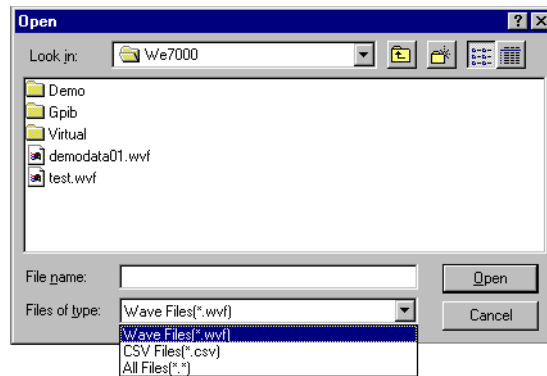

6. The setup data of the file being loaded appear in a dialog box as shown below. Select the channel and block that are to be loaded in the [Trace Name] and [Block No.] list boxes, respectively.

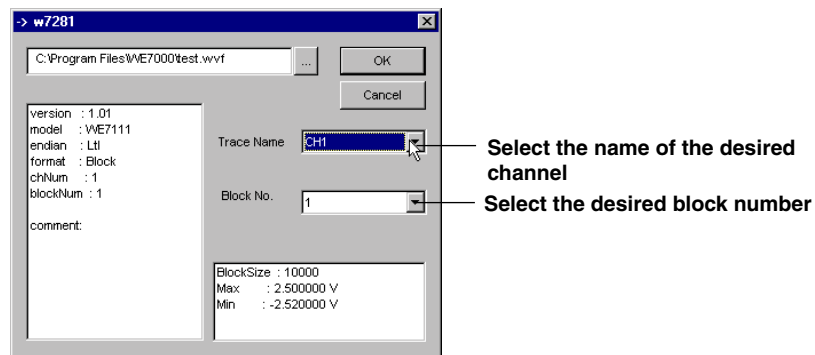

7. Click the [OK] button to load the waveform data to the channel that was selected in step 2. Only one block of a channel can be loaded with one operation.

## 3.4 Setting the Output Condition in the FG Mode

In this section, you will be using the operation panel that appears by double-clicking the module icon in the station list window as shown in the figure below.

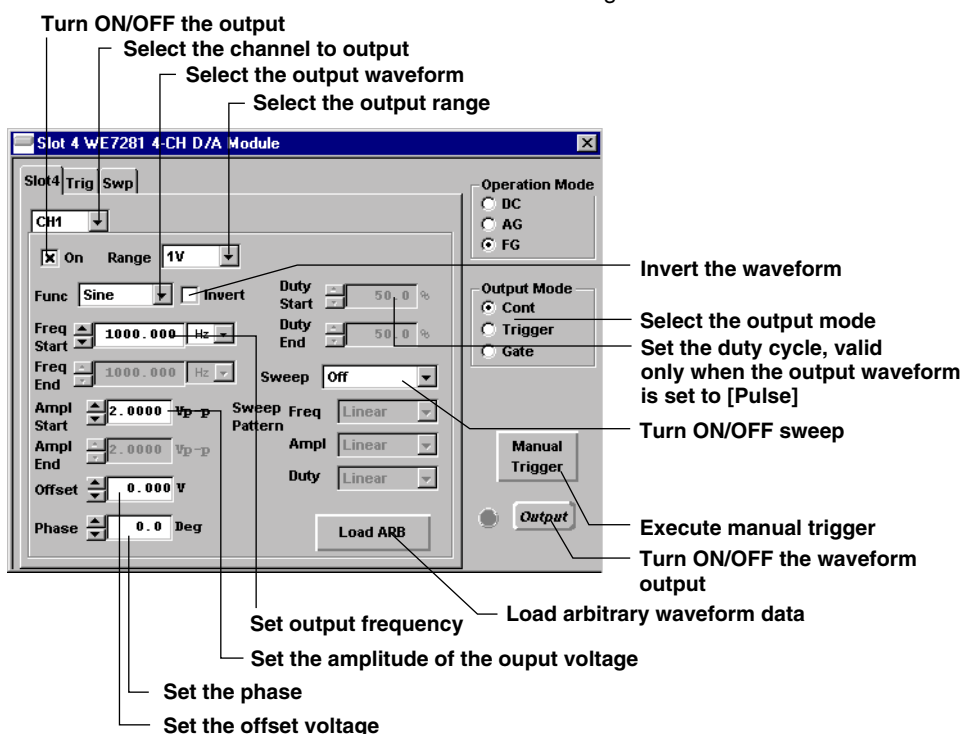

### Selecting the Output Channels and Range

Select the channel for which to set the output in the [CH] list box. Clicking the [On] box enables the output. Select the range from [1 V], [2 V], [5 V], and [10 V] in the [Range] list box.

### Selecting the Output Waveform

Select the output waveform in the [Func] list box. The choices are shown below. The default is [Sine].

- Sine : Sine wave
- Pulse : Pulse wave. Set the duty cycle from 0 to 100% (resolution: 0.1%).
- Ramp : Ramp wave
- Triangle : Triangular wave. Fixed to 50% symmetry.
- Arbitrary : Arbitrary wave
- DC : DC output (Set the output voltage in [Offset].)

### Setting waveform inversion

Check the [Invert] box to reverse the positive and negative polarities of the selected output waveform.

#### Setting the Duty Cycle

Enter the duty cycle in the [Duty Start] and [Duty End] entry boxes. The display changes so that values can be entered only when the output waveform is set to pulse wave. The [Duty End] entry box is set only when sweeping the duty cycle. The range is 0 to 100%. The resolution is 0.1%. The default is 50%.

---

**Note**

When the output waveform is pulse, the waveform may not be output if “(1/output frequency) x duty cycle setting < 10  $\mu$ s.” For output frequency settings, see the next section.

---

#### Setting the Output Frequency

Enter the output frequency in the [Freq Start] and [Freq End] entry boxes. [Freq End] is set only when sweeping the frequency. For the selectable range and resolution, see section 5.1, “Performance Specifications.” When the output waveform is a sine wave, the frequency can be set in the range from 1 mHz to 20 kHz. For all other waveforms, the frequency can be set in the range from 1 mHz to 10 kHz. The default is 1 kHz.

#### Setting the Amplitude of the Output Voltage

Enter the amplitude of the output voltage in the [Ampl Start] and [Ampl End] entry boxes. [Ampl End] is set only when sweeping the voltage. For the selectable range and resolution, see section 5.1, “Performance Specifications.” When the output waveform is set to DC, the output voltage is set to the offset voltage as described in the next section. The default amplitude is 2 Vp-p.

#### Setting the Offset Voltage

Enter the offset value of the output voltage in the [Offset] entry box. The range is confined to the output range. For the resolution, see section 5.1, “Performance Specifications.” The default is 0 V. When the output waveform is set to DC, this offset value is the output voltage.

#### Setting the Phase

Set the phase of the output waveform for each channel. Enter the initial phase at the start of the oscillation in the [Phase] entry box. The range is 0 to +360 deg regardless of the type of output waveform. The resolution is 0.1 deg. The default is 0 deg.

---

**Note**

The phase difference of the waveforms between channels will not necessarily be that which you specified between the channels. In addition, when the output waveform is set to a waveform other than pulse, the skew between the channels become large as the output frequency is lowered.

---

### Selecting the Output Mode

Select the output mode with the [Output Mode] option buttons. The choices are shown below. The default is [Cont].

**Cont: Continuous oscillation**

Continuously outputs the waveform from the time the output is turned ON by clicking the [Output] button until the output is turned OFF by clicking the [Output] button again.

**Trigger: Trigger oscillation**

After the [Output] button is clicked to turn ON the output, the waveform is continuously output when a trigger occurs. This continues until the output is turned OFF by again clicking the [Output] button.

**Gate: Gate oscillation**

After the [Output] button is clicked to turn ON the output, the oscillation starts when the gate is enabled. When the gate is disabled the oscillation stops. The waveform output unit is one cycle.

**Note**

---

When the output is OFF, the waveform output terminal of the module outputs 0 V.

---

### Loading Arbitrary Waveform Data

Load the arbitrary waveform data according to the following procedure.

1. Clicking the [Load ARB] button displays the following dialog box.

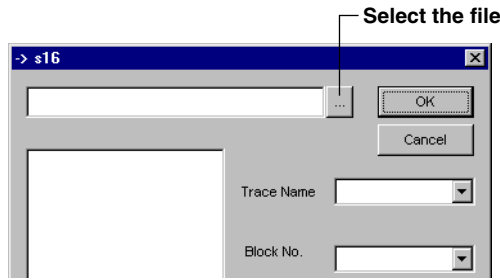

2. Clicking the button to the left of the [OK] button opens the [Open] dialog box. Select a file with extension [\*.wvf], [\*.csv], or [\*.s16] and click the [Open] button.

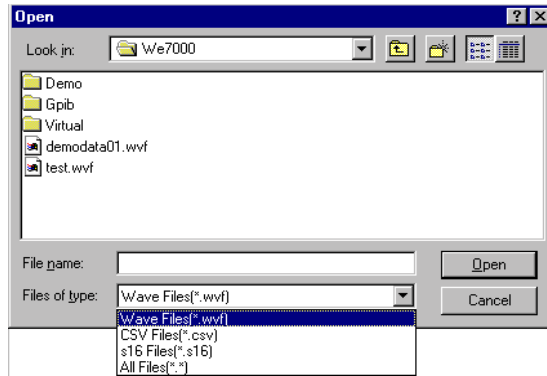

3. The setup data of the file being loaded appears in a dialog box as shown below. Select the channel and block that are to be loaded in the [Trace Name] and [Block No.] list boxes, respectively.

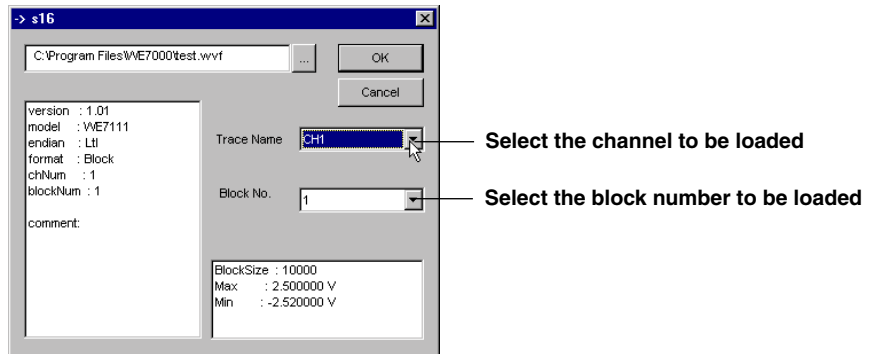

4. Click the [OK] button to load the arbitrary waveform data.

### Setting the Output Timing of the Trigger Signal

The trigger operation panel shown below is used to set the output timing.

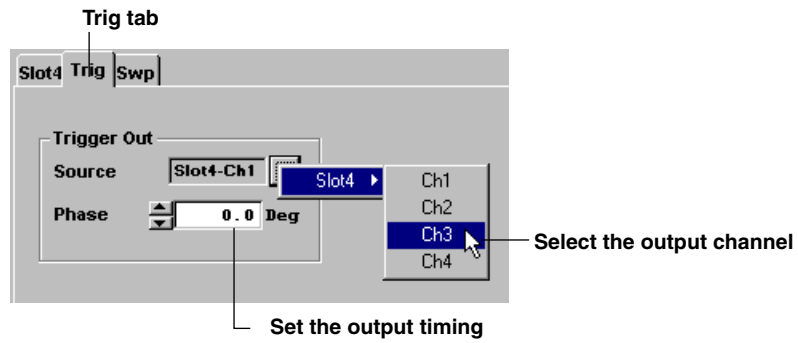

#### Selecting the source channel.

In the menu that appears by clicking the [Source] button, select the source channel that will be used to output the trigger signal.

#### Set the output timing

In the [Phase] entry box, specify at which phase of the output waveform of the source channel to output the trigger signal. The range is 0 to 360 deg.

### Setting the Sweep

The Main (SlotX) and Swp operation panels are used to set the sweep.

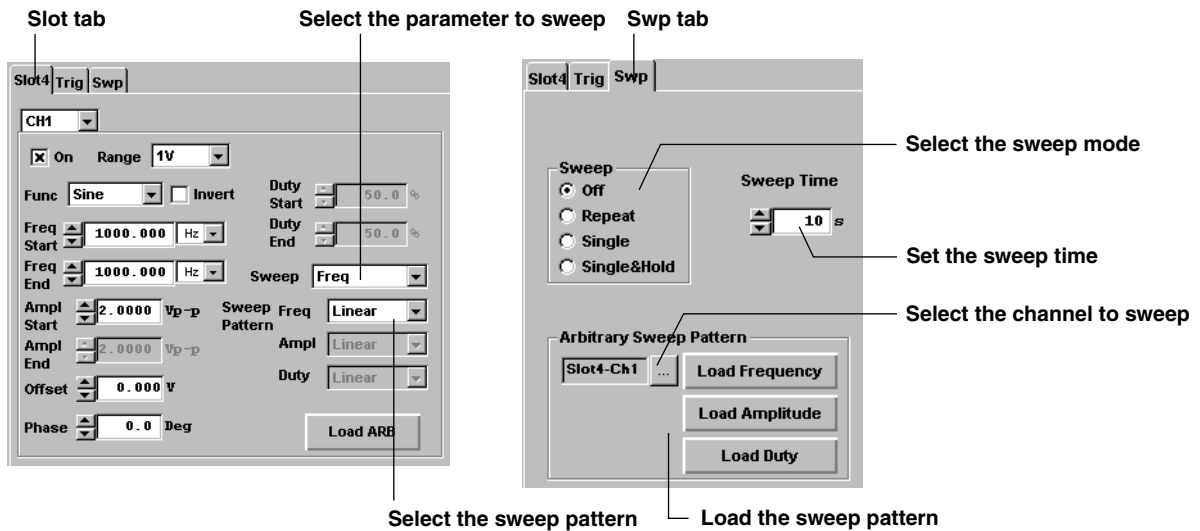

#### Selecting the parameter to sweep

Select which parameter to sweep in the Main operation panel. The choices are shown below.

- Off : Do not sweep
- Freq : Sweep the frequency
- Ampl : Sweep the amplitude
- Duty : Sweep the duty cycle
- Freq & Ampl : Sweep the frequency and amplitude

**Setting the start and end conditions of the sweep**

Enter a value in the [Freq Start] and [Freq End]/[Ampl Start] and [Ampl End]/[Duty Start] and [Duty End] entry boxes of the Main operation panel. The [...End] entry boxes are enabled only when the [Sweep] list box is set to something other than [Off]. For the selectable range, see section 5.1, "Performance Specifications."

**Selecting the sweep pattern**

Select the sweep pattern in the [Freq], [Ampl], or [Duty] list box located next to [Sweep Pattern] in the Main operation panel. Only the list box of the sweep parameter that was selected in the [Sweep] list box is selectable.

- Linear : Sweep linearly
- Log : Sweep logarithmically
- Arbitrary : Sweep using an arbitrary pattern

**Loading the Sweep Pattern**

**Selecting the channel that will use the sweep**

Click the channel selection button of the Swp operation panel, and in the menu that appears, select the channel that will use the sweep pattern.

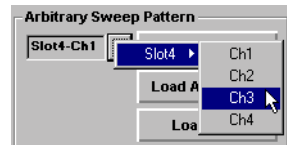

**Load**

Load the sweep pattern according to the following procedure.

1. Clicking the [Load] button of the desired parameter (Freq/Ampl/Duty) of the Swp operation panel opens the following dialog box.

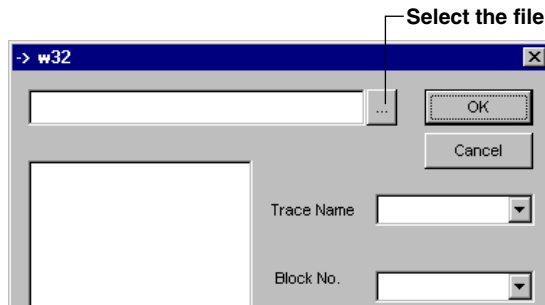

2. Clicking the button to the left of the [OK] button opens the [Open] dialog box. Select a file with extension [.wvf] or [.csv] and click the [Open] button.
3. The setup data of the file being loaded appear in a dialog box as shown below. Select the channel and block that are to be loaded in the [Trace Name] and [Block No.] list boxes, respectively.

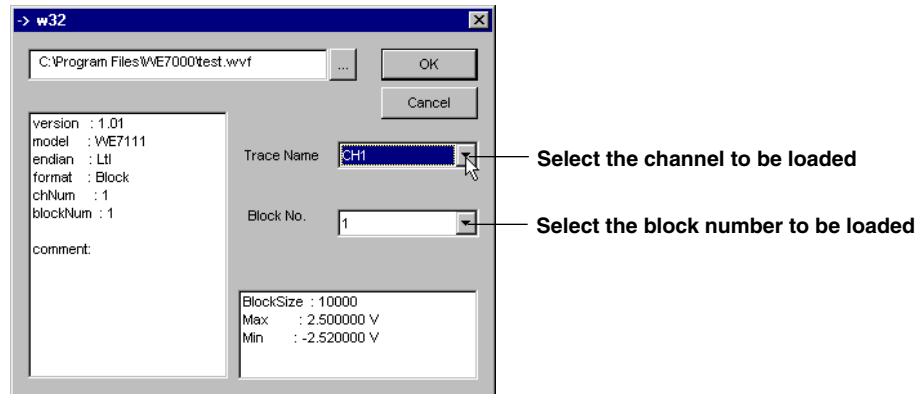

4. Click the [OK] button to load the sweep pattern.

#### Selecting the sweep mode

Select the sweep mode with the [Sweep] option buttons.

Off : Do not sweep

Repeat : Sweep repetitively

Single : Sweep once in sync with a trigger

Single&Hold : Perform a single sweep when a trigger occurs, then hold the last value and output a continuous oscillation waveform

#### Setting the sweep time

Set the time duration for one sweep operation in the [Sweep Time] entry box. The range is 1 s to 1000 s (in 1 ms steps).

## 3.5 Turning ON/OFF the Output

In this section, you will be using the operation panel which is shown in the figure below and that appears by double-clicking the module icon in the station list window.

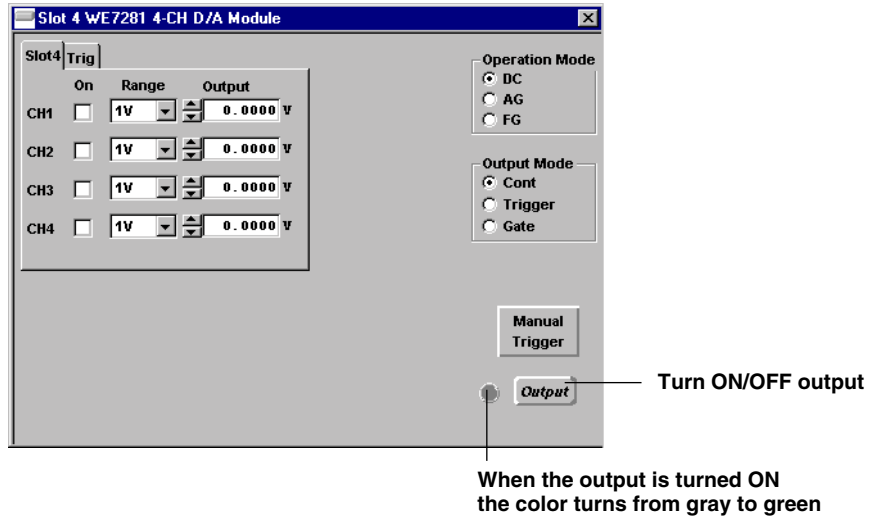

### Output ON

When the [Output] button is clicked, the black & white colors of the [Output] button are inverted, the "O" mark to the left of the button turns from gray to green, and the waveform output is enabled. In addition, the START indicator on the front panel of the module turns ON.

### Output OFF

When the [Output] button is clicked when a waveform is being generated, the black & white colors of the [Output] button return to their original colors, the "O" mark to the left of the button turns from green to gray, and the waveform output is aborted. In addition, the START indicator on the front panel of the module turns OFF.

#### Note

When the output is OFF, the waveform output terminal of the module outputs 0 V.

## 4.1 Troubleshooting

- If servicing is necessary, or if the instrument is not operating correctly after performing the following corrective actions, contact your nearest YOKOGAWA dealer.
- To verify that the module is operating correctly, perform the self test as described on the next page.

Problem	Probable Cause/Corrective Action	Reference
Module does not operate.	Check to see that the module is installed correctly into the station. Also, install the module into another slot, and check whether it will operate there. If it operates in the other slot, the measuring station is likely to have malfunctioned. If the module is installed correctly and does not operate, the connector might be bad or the IC may have malfunctioned. In either case, contact your nearest YOKOGAWA dealer to have it repaired.	2-1, 3-1, *
There is no waveform output	Check whether the "O" indicator on the left of the [Output] button is green. If the waveform is a trigger oscillation or gate oscillation, check that the settings are correct.	3-15 3-2, 3-4, 3-10
The Output waveform is not correct	Check to see that the output waveform setting and output conditions are correct.	3-1 to 3-15
Cannot set the waveform	Check that the settings you are trying to enter are within the specifications.	5-1 to 5-3

\* See WE7000 User's Manual (IM 707001-01E).

## 4.2 Self Test

If you believe that the module is not operating correctly, perform the self test according to the following steps.

### Executing Self Test

1. Disconnect cables that are connected to the module.
2. Select [Self Test] from the [System] menu of the WE7000 Control Software.



3. In the [Self Test] dialog box that appears, select the station name and enter the slot number corresponding to the module, and click the [Execute] button.

“Executing...” is displayed in the result display box.

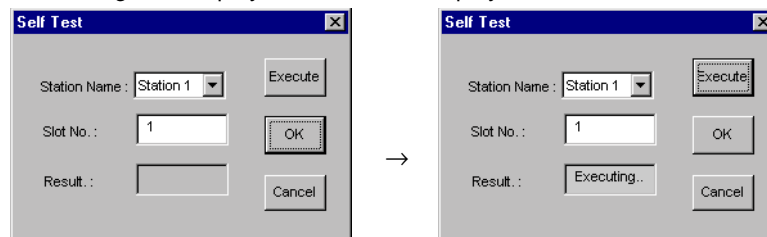

### Verifying Test Results

If a value other than “0” is displayed in the “Result” display box of the “Self Test” dialog box, the module is probably malfunctioning. Please contact your nearest YOKOGAWA dealer.

---

## 4.3 Maintenance

### Maintenance of Parts

There are no parts in this module that require periodic replacement.

### Calibration

We recommend that you calibrate the measurement module once a year to assure its accuracy. Please contact your nearest YOKOGAWA dealer to have the module calibrated.

## 5.1 Performance Specifications

The following performance specifications are attained under standard operating conditions (section 5.3 “General Specifications”).

### Common

#### Number of output channels

4 channels

#### Output format

Floating unbalanced output, isolated between channels

#### D/A resolution

16 bits (includes the sign)

#### Output range

$\pm 1$  V,  $\pm 2$  V,  $\pm 5$  V,  $\pm 10$  V

#### Maximum output current

$\pm 10$  mA (per channel)

#### Allowable load resistance

1 k $\Omega$  or more

#### Output impedance

1  $\Omega$  or less

### During DC Output

#### DC accuracy

(at ambient temperature of  $23\pm 5^\circ\text{C}$ , ambient humidity of  $50\pm 10\%$ RH, after the warm-up time has passed)

Range	Resolution	DC Accuracy	Temperature Coefficient (5-18°C, 28- 40°C)
$\pm 1$ V	0.1 mV	$\pm(0.05\%$ of setting+0.5 mV)	$\pm(50$ ppm of setting+33 $\mu\text{V}/^\circ\text{C}$
$\pm 2$ V	1 mV	$\pm(0.05\%$ of setting+1 mV)	$\pm(50$ ppm of setting+54 $\mu\text{V}/^\circ\text{C}$
$\pm 5$ V	1 mV	$\pm(0.05\%$ of setting+2 mV)	$\pm(50$ ppm of setting+116 $\mu\text{V}/^\circ\text{C}$
$\pm 10$ V	1 mV	$\pm(0.05\%$ of setting+4 mV)	$\pm(50$ ppm of setting+220 $\mu\text{V}/^\circ\text{C}$

#### Settling time

32  $\mu\text{s}$  (until the value settles within  $\pm 0.1\%$  of the final value, typical value\*)

#### Trigger source

Manual, bus trigger signal (BUSTRG1/BUSTRG2) of the measuring station.

### During Function Waveform (FG) Output

#### Output waveform

Sine, pulse (variable duty cycle), ramp, triangular, arbitrary, and DC.

#### Output frequency range and resolution

1 MHz to 20 kHz (Sine wave), 1 MHz to 10 kHz (other waves)

Resolution: 1 mHz

#### Output frequency accuracy

$\pm(0.01\%$  of setting + 23  $\mu\text{Hz}$ )

#### maximum output voltage

Range within the output range

#### Amplitude range and accuracy

(at ambient temperature of  $23\pm 5^\circ\text{C}$ , ambient humidity of  $50\pm 10\%$ RH, after the warm-up time has passed.)

Range Setting	Selectable range	Resolution	Accuracy (for 1-kHz sine wave)
$\pm 1$ V	0 to 2 Vp-p	0.1 mVp-p	$\pm 4$ mVp-p
$\pm 2$ V	0 to 4 Vp-p	1 mVp-p	$\pm 8$ mVp-p
$\pm 5$ V	0 to 10 Vp-p	1 mVp-p	$\pm 20$ mVp-p
$\pm 10$ V	0 to 20 Vp-p	1 mVp-p	$\pm 40$ mVp-p

#### Offset voltage range and accuracy

Range Setting	Selectable Range	Resolution	Accuracy
$\pm 1$ V	-1 to 1 V	0.1 mV	$\pm 2$ mV
$\pm 2$ V	-2 to 2 V	1 mV	$\pm 4$ mV
$\pm 5$ V	-5 to 5 V	1 mV	$\pm 10$ mV
$\pm 10$ V	-10 to 10 V	1 mV	$\pm 20$ mV

**Amplitude frequency characteristics (when generating maximum voltage at each range, with an offset voltage of 0 V, and measuring the rms value at 1 kHz as reference)\*<sup>1</sup>**

Sine :  $\leq 20$  kHz +0/-0.34 dB

Pulse :  $\leq 10$  kHz +0/-3.2%

Triangular :  $\leq 10$  kHz +0/-3.2%

Ramp :  $\leq 10$  kHz +0/-12.9%

**Sine wave purity (when generating maximum voltage at each range, with an offset voltage of 0 V)\*<sup>1</sup>**

Harmonics (the maximum value in 2 to 5th order harmonics)

1 kHz : -55 dBc or less

10 kHz : -50 dBc or less

Suprious (frequency range of 1 kHz to 100 kHz)

1 kHz : -55 dBc or less

10 kHz : -50 dBc or less

**Pulse wave characteristics (when generating maximum voltage at each range, with an offset voltage of 0 V)\*<sup>1</sup>**

Rise time : 1.2 ms (10% to 90%, typical value\*<sup>2</sup>)

Overshoot : Less than or equal to  $\pm 0.5\%$  of the output p-p value (typical value\*<sup>2</sup>)

Output jitter :  $\pm 5$   $\mu$ s

Duty cycle setting

Range : 0 to 100% (resolution 0.1%)

Time accurary :  $\pm((0.01\% \text{ of } 1/\text{the output frequency}) + 5 \mu\text{s})$

**Phase**

Target: Start and stop phase of trigger oscillation, gate oscillation, and continuous oscillation

Range:  $\pm 360^\circ$  (Resolution:  $0.1^\circ$ )

**Output operation**

Continuous, trigger, and gate

**Trigger source**

Manual, bus trigger signal (BUSTRG1/BUSTRG2) of the measuring station.

**Gate source**

Manual, bus trigger signal (BUSTRG1/BUSTRG2) of the measuring station.

**Sweep function**

Frequency, amplitude, both frequency and amplitude simultaneously, duty cycle (only for pulse wave)

**Sweep mode**

Linear, log, and arbitrary pattern

**Sweep time**

1 s to 1000 s

**Sweep time resolution**

1 ms

**Sweep time accuracy**

$\pm(0.033\% \text{ of setting})$

**Bus trigger output**

Output at an arbitrary phase angle of the specified channel.

**Bus trigger output time accuracy**

$\pm 12.5 \mu\text{s}$

**During Arbitrary Waveform (AG) Output****Maximum D/A sampling interval**10  $\mu$ s**Sampling clock source**

Internal, or the time base signal (CMNCLK) of the measuring station

**Internal clock interval**10  $\mu$ s to 10 s**Internal clock interval resolution**10  $\mu$ s**Memory length**

1 MWord/CH (at 4 CH), 2 MWord/CH (at 2CH), or 4 MWord/CH (at 1CH)

**Memory partitions**

1, 2, 4, 8, 16, 32, 64, 128, or 256

**Waveform pattern length**

10 to (memory length/the number of memory partitions)

**Waveform output mode**

Single, continuous, single by triggering, and continuous by triggering

**Trigger source**

Manual, bus trigger signal (BUSTRG1/BUSTRG2) of the measuring station.

**Bus trigger output**

Output at an arbitrary sample of the specified channel.

**Bus trigger output time accuracy** $\pm$  (sampling interval + 7.5  $\mu$ s)**Synchronized Operation****Skew between channels**Within the same module : 1.5  $\mu$ s (typical value\*<sup>2</sup>)Between adjacent modules: 1.6  $\mu$ s (typical value\*<sup>2</sup>)\*<sup>1</sup> Using an output cable of length 3 m or less.\*<sup>2</sup> Typical value represents a typical or average value. It is not strictly guaranteed.

---

## 5.2 Default Values (Factory Default Settings)

Operation Mode: DC  
Mode: Cont  
CH1 to CH4: Off  
Range: 1 V  
Output: 0.000 V  
Trigger Output Source: CH1 of its own module  
Output: Off

### **Operation Mode: During AG**

Mode: One Shot  
CH1 to CH4: Off  
Range: 1 V  
Sampling Interval: 10 us ( $\mu$ s)  
Memory Partition: 1  
Start Block No.: 1  
Stop Block No.: 1  
Output: Off  
Trigger Out Point: 1  
Auto: On  
CH MODE: 4ch  
Time Base: Internal  
Manual: CH1 of its own module  
Block No.: 1

### **Operation Mode: During FG**

Mode: Cont  
CH1 to CH4: Off  
Range: 1 V  
Function: Sine  
Freq Start: 1000 Hz  
Freq End: 1000 Hz  
Ampl Start: 2 Vp-p  
Ampl End: 2 Vp-p  
Offset: 0 V  
Phase: 0°  
Duty Start: 50.0%  
Duty End: 50.0%  
Delay: 0 V  
Invert : Off  
Trigger Out Source: CH1 of its own module  
Trigger Out Phase: 0 Deg  
Sweep: Off  
Sweep Time: 10.0 s

## 5.3 General Specifications

### Safety Standards

- Complies with CSA C22.2 No.1010.1 and EN61010-1, conforms to JIS C1010-1
- Overvoltage Category CAT I and II<sup>1</sup>
  - Pollution Degree 1 and 2<sup>2</sup>

### EMC Standards

#### Emission

Complying Standard

EN55011 Group 1 Class A

This product is a Class A (for industrial environment) product. Operation of this product in a residential area may cause radio interference in which case the user is required to correct the interference.

#### Immunity

Complying Standard

EN50082-2

Testing Condition

- WE7281: Connect with the 3 m twisted pair wire.
- WE7282: Connect with the 3 m coaxial cable (3D-2W).

### Standard Operating Conditions

Ambient temperature: 23±5°C, Ambient humidity: 50±10%RH, Error on supply voltage/frequency: within 1% of rating, after the warm-up time has passed

### Warm-up Time

At least 30 minutes

### Maximum Common-Mode Voltage (between L Terminal and Ground)

WE7281: ±250 VDC or ±250 VACrms

WE7282: ±42.4 VDC + ACpeak

### Maximum Voltage between Channels

WE7281: ±250 VDC or ±250 VACrms

WE7282: ±42.4 VDC + ACpeak

### Withstand Voltage

#### Between output terminal and ground

WE7281/WE7282: 1500 VACrms at 60 Hz for one minute

#### Between channels

WE7281: 2300 VACrms at 60 Hz for one minute

WE7282: 1500 VACrms at 60 Hz for one minute

### Insulation Resistance (between Output Terminal and Ground and between Channels)

10 MΩ or more at 500 VDC

### Output Connector

WE7281: Clamp type terminal (terminal block is detachable)

WE7282: Isolated BNC

### Maximum Output Cable Length

20 m (However, the output waveform may distort if the cable length exceeds 3 m.)

### Operating Conditions

Same as those of the measuring station

### Storage Conditions

Temperature: -20°C to 60°C

Humidity: 20% to 80%RH (no condensation)

### Power Consumption

15 VA (typical value\*3 at 100 V/50 Hz)

### External Dimensions

Approx. 33(W) × 243(H) × 232(D) mm (projections excluded)

### 5.3 General Specifications

---

#### **Weight**

Approx. 0.9 kg

#### **Number of Used Slots**

1

#### **Standard Accessories**

WE7281: Terminal block (1) (attached to the output connector at the time of shipment)

User's Manual (1)

WE7282: User's Manual (1)

#### **Optional Accessories**

WE7281: Terminal block (Model: A1460JT)

WE7282: None

\*<sup>1</sup> Overvoltage Categories define transient overvoltage levels, including impulse withstand voltage levels.

Overvoltage Category I: Applies to equipment supplied with electricity from a circuit containing an overvoltage control device.

Overvoltage Category II: Applies to equipment supplied with electricity from fixed installations like a distribution board.

\*<sup>2</sup> Pollution Degree: Applies to the degree of adhesion of a solid, liquid, or gas which deteriorates withstand voltage or surface resistivity.

Pollution Degree 1: Applies to closed atmospheres (with no, or only dry, non-conductive pollution).

Pollution Degree 2: Applies to normal indoor atmospheres (with only non-conductive pollution).

\*<sup>3</sup> Typical value represents a typical or average value. It is not strictly guaranteed.

## 5.4 Dimensional Drawings

Unit: mm

### 4-CH, 100kS/s D/A Module

WE7281

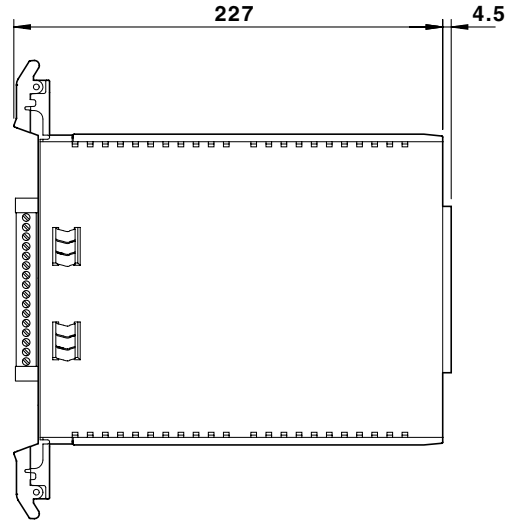
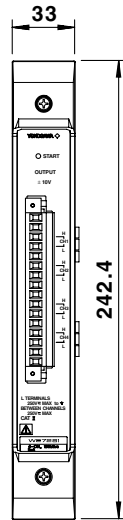

WE7282

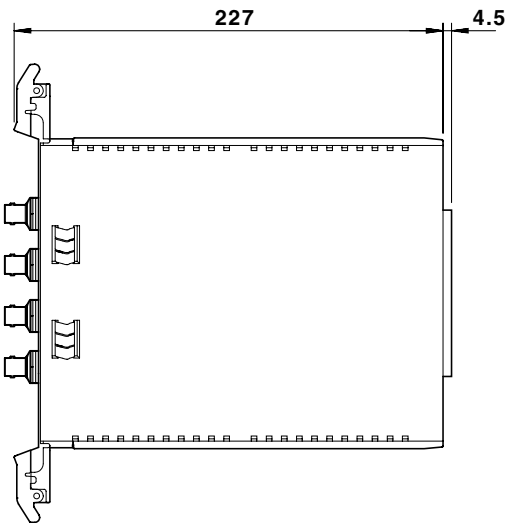
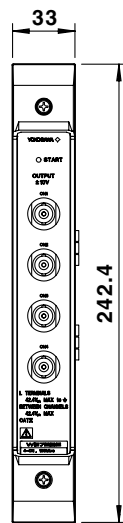

If not specified, the tolerance is  $\pm 3\%$ . However, in cases of less than 10 mm, the tolerance is  $\pm 0.3$  mm.

# Index

## A

AG mode ..... 1-3, 1-5, 3-4  
 Ampl ..... 3-10  
 Amplitude, setting ..... 3-10  
 Arbitrary ..... 1-11  
 Arbitrary waveform data ..... 1-7, 1-13  
 Arbitrary waveform data, loading ..... 3-6, 3-12  
 ASCII data in csv format ..... 1-7, 1-13  
 Auto ..... 3-6  
 Auto load ..... 1-7, 3-6

## B

Block ..... 1-5, 3-6  
 Block No. .... 3-7  
 Bus trigger signals ..... 1-14

## C

Channels used, number of ..... 3-6  
 Cont (AG) ..... 1-6, 3-4  
 Cont (DC) ..... 3-2  
 Cont (FG) ..... 1-9, 3-11  
 Continuous oscillation ..... 3-4, 3-11

## D

Data length ..... 1-5, 3-6  
 DC mode ..... 1-4, 3-2  
 Duty cycle ..... 3-10  
 Duty End ..... 3-10  
 Duty Start ..... 3-10

## F

FG mode ..... 1-3, 1-8, 3-9  
 Freq End ..... 3-10  
 Freq Start ..... 3-10  
 Front Panel ..... 1-15  
 Func ..... 3-9  
 Function, selecting ..... 1-8

## G

Gate (DC) ..... 3-2  
 Gate (FG) ..... 3-11  
 Gate oscillation ..... 1-9, 3-11

## I

Invert ..... 3-9

## L

Linear ..... 1-11  
 Log ..... 1-11

## M

Manual ..... 3-7  
 Manual load ..... 1-7, 3-7  
 Memory partition ..... 1-5, 3-6  
 MODEL ..... 2

## N

NO ..... 2

## O

Offset ..... 3-10  
 Offset voltage, setting ..... 3-10  
 One Shot ..... 1-6, 3-4  
 Operation Mode ..... 3-1  
 Operation principle ..... 1-1  
 Output button ..... 3-16  
 Output entry box ..... 3-2  
 Output frequency ..... 1-10  
 Output frequency, setting ..... 3-10  
 Output Mode ..... 1-4  
 Output Mode (AG) ..... 3-4  
 Output Mode (DC) ..... 3-2  
 Output Mode (FG) ..... 3-11  
 Output ON/OFF ..... 3-16  
 Output timing ..... 3-5, 3-13  
 Output waveform, selecting ..... 3-9

## P

Package ..... 2  
 Phase ..... 1-10, 3-10  
 Pin arrangement ..... 2-3  
 Principle of operation ..... 1-1

## R

Range ..... 3-2  
 Repeat ..... 1-6, 3-4

## S

Sampling interval ..... 1-5, 3-5  
 Self test ..... 4-2  
 Signal wire, connecting ..... 2-3  
 Single&Hold ..... 1-12  
 Source (DC) ..... 3-3  
 Source (FG) ..... 3-13  
 Sweep mode ..... 1-12, 3-15  
 Sweep parameter ..... 1-11, 3-13  
 Sweep pattern ..... 3-14  
 Sweep, start and end conditions of ..... 3-14  
 Sweep time ..... 1-12, 3-15  
 System configuration ..... 1-2

## T

Terminal block, pin arrangement of ..... 2-3  
 Time base ..... 1-5, 3-5  
 Trigger (AG) ..... 1-6, 3-4  
 Trigger (DC) ..... 3-2  
 Trigger (FG) ..... 1-9, 3-11  
 Trigger oscillation ..... 3-4, 3-11  
 Troubleshooting ..... 4-1

## W

Waveform inversion, setting ..... 3-9  
 wvf file ..... 1-7